

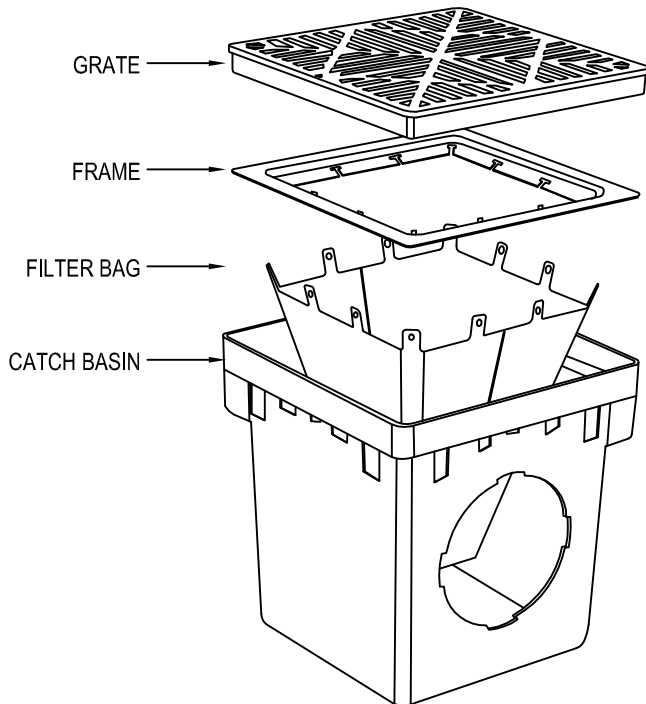

NDS, INC.
 851 NORTH HARVARD AVE.
 LINDSAY, CA 93247
 TOLL FREE: 1-800-726-1994
 PHONE: (559) 562-9888
 FAX: (559) 562-4488
 www.ndspro.com

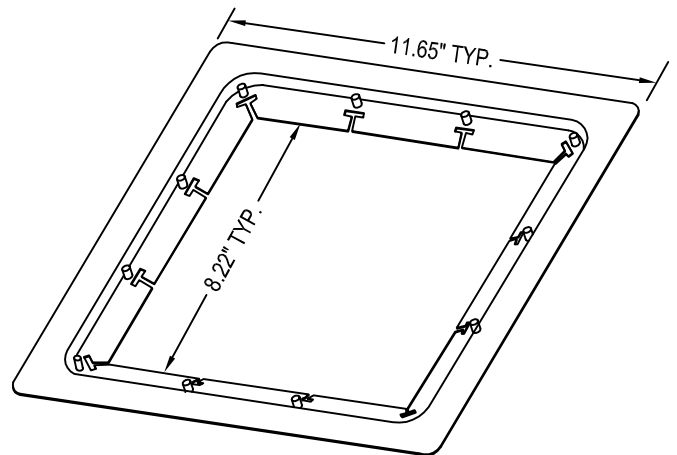

ISOMETRIC



FRAME

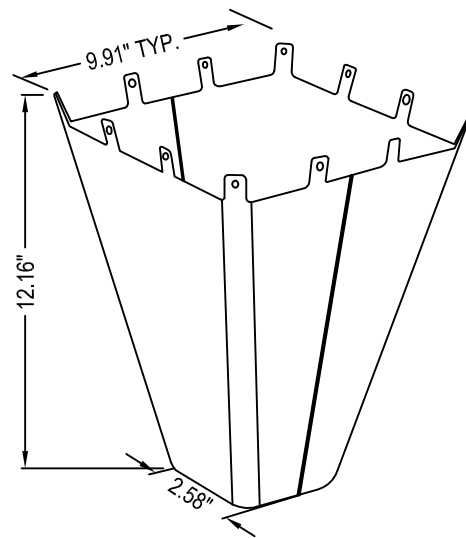

FILTER BAG

PRODUCT SPECIFICATIONS:

PART #: 1200FF
FRAME MATERIAL: POLYPROPYLENE
BODY COLOR: BLUE
FILTER BAG MATERIAL: NONWOVEN SPUNBONDED, POLYPROPYLENE GEOTEXTILE. INERT TO BIOLOGICAL DEGRADATION AND RESISTANT TO NATURALLY ENCOUNTERED CHEMICALS, ALKALIS AND ACIDS.
WATER FLOW RATE: (ASTM D 4491) 95 GPM/SF
OPENING SIZE: 50 US STD. SIEVE
TRAPEZOIDAL TEAR: (ASTM D 4533) 40 LBS.
UV RESISTANCE: (ASTM D 4355) 70% @ 500 HRS
FITS: 12" NDS CATCH BASINS
WEIGHT: 0.10 LBS.

NOTES:

1. EXISTING SOILS SHOULD BE EVALUATED TO ENSURE PROPER STRUCTURAL AND PERMEABILITY PROPERTIES.
2. INSTALLATION TO BE COMPLETED IN ACCORDANCE WITH MANUFACTURER'S SPECIFICATIONS.
3. DO NOT SCALE DRAWING.
4. THIS DRAWING IS INTENDED FOR USE BY ARCHITECTS, ENGINEERS, CONTRACTORS, CONSULTANTS AND DESIGN PROFESSIONALS FOR PLANNING PURPOSES ONLY.
5. ALL INFORMATION CONTAINED HEREIN WAS CURRENT AT THE TIME OF DEVELOPMENT BUT MUST BE REVIEWED AND APPROVED BY THE PRODUCT MANUFACTURER TO BE CONSIDERED ACCURATE.

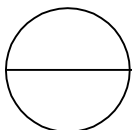

INFILTRATION

12" CATCH BASIN FILTER