



NDS®
We put water in its place

Your knowledgeable and trusted partner for the best in water management solutions



Residential Stormwater Management | Commercial Stormwater Management | Professional Irrigation | Flow Management

2024 | 2025

Product Catalog

ndspro.com

MADE IN
USA



LANDSCAPE



LANDSCAPE

ROOT BARRIER PANELS



Root barrier products direct root growth from shrubs and trees downward, dramatically decreasing the roots' potential to clash with and penetrate nearby hardscapes, walls, or building foundations. The use of NDS root barriers for residential and non-residential landscapes protects many communities and homeowners against the high cost of reparations due to cracks in foundations and buckled sidewalks and driveways.

Modular EP Series Root Barrier Panels

EP Series Root Barrier Panels are made from injection molded High Impact Polypropylene (HIPP) with a unique factory installed joiner strip that eases installation. EP Series Panels include a "T" top edge to prevent root overgrowth and an Anchor Lock™ external flange at the base to lock panels in the ground. Suitable for all planting installations, EP Series Root Barrier Panels are available in 12", 18", 24" and 36" depths.

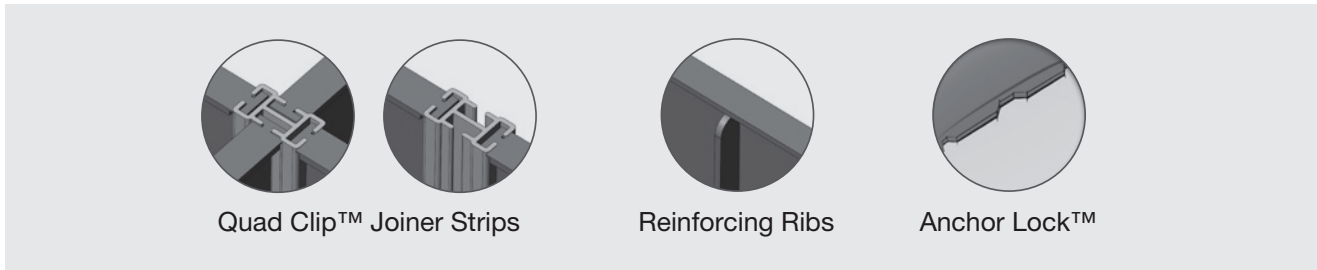

Quad Clip™ Joiner Strips



Reinforcing Ribs

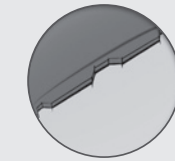
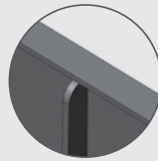

Anchor Lock™

Specifications

EP Series Root Barrier Panels by NDS include factory installed independent joiner strips. Each Barrier is a minimum of 0.090 inches thick and is made of up to 50% post consumer High Impact Polypropylene (HIPP) with U.V. inhibitors to ensure longevity. Barrier Panels have 1/2" raised vertical ribs running perpendicular to the panel and are 6" on center. All EP Series Panels feature a 3/8" wide "T" top edge and an external ground anchoring base flange that is 1/8" in width.

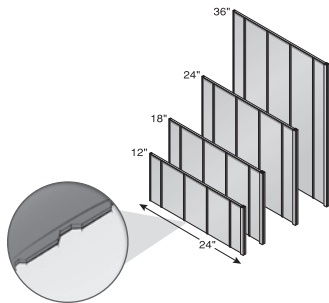

Part No.	Description	Color	Pkg. Qty.	Wt. Ea. Lbs.	Product Class
EP-1250	12" x 24" Root Barrier Panel	Black	25	1.80	50LP
EP-1850	18" x 24" Root Barrier Panel	Black	25	1.56	50LP
EP-2450	24" x 24" Root Barrier Panel	Black	25	2.12	50LP
EP-3650	36" x 24" Root Barrier Panel	Black	25	3.20	50LP
RP-4850	48" x 24" Root Barrier Panel	Black	25	6.20	50LP

Includes 1 Joiner Strip per panel

Recommended Installations

Surround Application:	Linear/Root Pruning Application:
Panels placed around root ball, at a sufficient distance to allow proper backfill of materials.	Panels placed directly adjacent to the hardscape being protected.

LANDSCAPE

ROOT BARRIER PANELS

Root Barrier Sheet Material

Manufactured from durable HDPE, Root Barrier Sheet Material creates a water and root barrier to prevent costly damage to pavements, roads, and building foundations caused by water and roots. The 20-foot-long sheets of material are ideal for linear style planting applications, and are equally suited for individual tree planting use. Root Barrier Sheet Material is available in 12", 18", and 24" depths to meet a variety of applications.

LANDSCAPE

- A - Finished Grade
- B - 3" - 4" of 3/4" Gravel
- C - Amended Soil
- D - Sheet Material

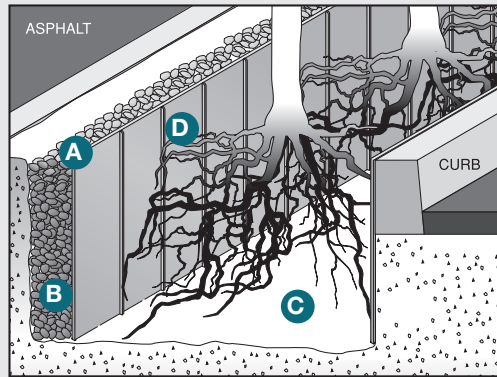

Specifications

Root Barrier Sheet Material by NDS is manufactured from up to 50% recycled HDPE with U.V. inhibitors with a thickness of 0.040 - 0.060". Barriers feature vertically integrated and flared molded 90° root-deflecting ribs that protrude 1/2" from wall and are placed 6-8" apart. A root impervious molded end provides easy assembly using staples or a sealant design to bind to HDPE (a dual-sided solvent-based tape).

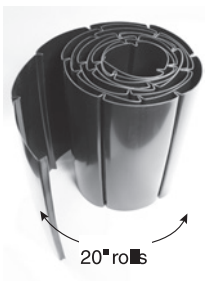

Part No.	Description	Color	Pkg. Qty.	Wt. Ea. Lbs.	Product Class
SM-1220	12" x 20 ft. Roll	Black	1	10.00	50LP
SM-1820	18" x 20 ft. Roll	Black	1	14.00	50LP
SM-2420	24" x 20 ft. Roll	Black	1	18.00	50LP
SM-3620	36" x 20 ft. Roll	Black	1	22.00	50LP

Recommended Installations

Surround Application:

Cut desired length of molded roll material. Connect the ends by overlapping two 6" sections with the leading rib cut directly down the middle. If using a sealant to seal the ends, utilize a dual-sided solvent-based tape (like that sold by Tuff Industries, Inc.). Install by placing the Sheet Material around root ball at a sufficient distance to allow proper backfill – the vertical integrated root-deflecting ribs should always be facing the root ball.

Linear/Root Pruning Application:

Cut desired length of molded roll material and install directly adjacent to hardscape being protected

TRUNK PROTECTOR

Used around the base of trees to prevent damage from lawnmowers, edgers, and string trimmers. The coiled shape allows it to expand with the growth of the tree. It is vented, which permits the tree to breathe and it is notched at the base to accommodate root flare. NDS Trunk Protector is colored to help it blend with the natural shade of the tree. Each unit fits up to a 4" caliper tree; multiple units may be used for larger trees.

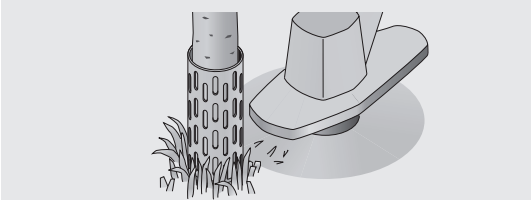

Specifications

Trunk Protector by NDS is made of Low Density linear Polyethylene (LDLPE) material with U.V. inhibitors to insure longevity. Trunk Protector measures 8" high, 12" wide and ± 0.050" thick. Slotted vents are 1" high by 1/4" wide, creating a serrated lower edge on the bottom row.

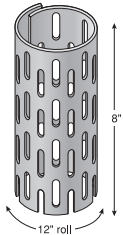

Part No.	Description	Color	Pkg. Qty.	Wt. Ea. Lbs.	Product Class
TP-128	Trunk Protector	Gray	50	0.16	50LP

Recommended Installations

Any tree planted in lawn or brush areas where mowing or trimming equipment may cause contact with tree trunks.

LANDSCAPE

LANDSCAPE PRODUCTS INDEX

Part No.	Page	Part No.	Page	Part No.	Page	Part No.	Page
EP-1250	97	EP-3650	97	SM-1820	98	TP-128	99
EP-1850	97	RP-4850	97	SM-2420	98		
EP-2450	97	SM-1220	98	SM-3620	98		

You Click, You Order. No Waiting.

Getting connected is easy... set up your account online, or call customer service. 800-7261994. Se Habla Español.

ndspro.net

The 24 hour online dealer tool that helps you manage your NDS Business

Pricing Query

Instant Order Entry, No Wait

Check Discount Schedules

Check Order Status

Invoice Printing

Inventory Query

Manage Your Account

News Updates

Links to ndspro.com and Literature Direct



NEW! Shopping Cart
Easy to Use & Convenient

TERMS AND CONDITIONS OF SALE

Terms: Standard terms are NET 30 days. All invoices are to be paid in US Currency. Title and risk of loss pass to buyer upon shipment.

Freight Allowance: Freight prepaid on orders of \$2000.00 NET or more, with the exception of shipments to HI, Canada, AK, and PR Prepaid freight levels are based on shipments to one location only. It is the responsibility of the customer to determine if his purchase order meets the minimum freight allowance required. NDS reserves the right to select the carrier and point of shipment.

Canada, Hawaii, Puerto Rico & Alaska orders that include EZflow must be a minimum of \$4000 for prepaid freight Terms.

Canada, Puerto Rico & Alaska: Freight prepaid on orders of \$2500.00 (US\$) NET or more.

Hawaii Orders: Freight prepaid on orders of \$3500 NET or more.

Errors & Claims: All claims for shortage in shipment or damaged material must be noted on the “Bill of Lading” and a written request for credit submitted to NDS within 15 days of shipment. NDS responsibility ceases upon delivery to the carrier.

Returned Goods: Returned goods will be accepted only after written approval and shipping instructions are received from NDS. A return goods authorization number is required and must be on all cartons, documents, and correspondence. All returns are subject to a 25% restocking charge, freight cost of returned goods (plus “out freight if applicable”). A higher restocking charge may be assessed against any return requiring extraordinary handling costs.

Minimum Order: \$100.00 minimum order net billing.

Broken Box Charge: A 25% broken box charge will be added for other than full box quantities. 21DI Drip Components, 25DS Dura Slope Channel and 25FC Filcoten Channel are excluded from this policy.

Limited One Year Warranty: The liabilities of NDS are limited solely and exclusively to replacement as set forth in our standard “Statement of Warranty”, alone and do not include any liability for incidental, consequential or other damage of any kind whatsoever, whether any claim is based upon theories of contract, warranty, negligence or tort and without any limitations and do not include shipping charges, labor, installation or any other losses or expenses incurred in operation of any replacement specialty item or fitting. NDS drainage products are designed to be used for exterior surface drainage only.

All NDS products are guaranteed against defects resulting from faulty workmanship or materials. Claims for labor costs and other expenses required to replace defective products or repair of any damage resulting from the use thereof will not be allowed by NDS. Our liability is limited to replacement of products acknowledged by NDS to be defective.

Exclusive Warranties and Remedies: The foregoing remedies are exclusive and are given and accepted in lieu of (i) any and all other warranties, expressed or implied, including without limitation the implied warranties of merchantability and fitness for particular purpose; and (ii) any obligation, liability, right, claim or remedy in contract or tort, whether or not arising from NDS, Inc.’s negligence, actual or imputed. The remedies of customer shall be limited to those provided herein to the exclusion of any and all other remedies including, without limitation, incidental or consequential damages. No agreement varying or extending the foregoing warranties or these limitations will be binding on NDS, Inc., unless such is signed in writing by an authorized officer of NDS, Inc.

The liability of NDS, Inc., hereunder shall be limited to restoring to good working order, provided that NDS, Inc., is not required to restore the product to good working order when such failure is due to causes beyond NDS, Inc.’s control, including but not limited to, acts of God, acts of civil or military authority, priorities, strikes, floods, epidemics, war, riots, and other causes that are beyond the manufacturers control.

These provisions are complete and exclusive statements of all terms and conditions between NDS, Inc., and the consumer. These provisions may not be varied, supplemented, qualified or interpreted by any prior course of dealings, written or oral or by trade usage. No NDS, Inc. agent, officer or employee has authority to make any representation, promise or warranty concerning these provisions.

FOR TECHNICAL INFORMATION, CONTACT: Technical Services, (888) 825-4716, TechService@ndspro.com

Visit ndspro.com for more information.

Our products are engineered and produced for performance, durability, ease of installation and the efficient use of resources.



Your knowledgeable and trusted partner for the best in water management solutions



Residential Stormwater Management | Commercial Stormwater Management | Professional Irrigation | Flow Management

Visit ndspro.com for:



Videos



Tools/
Calculators



Downloads



Case
Studies



Design
Worx



Request
a Quote

ndspro.com

NDS Customer Service
851 N. Harvard Ave., Lindsay, CA 93247
Phone: 800.726.1994 · 559.562.9888
Fax: 800.726.1998 · 559.562.4488
Se Habla Español

Download our
**Mobile App - Search
for NDS Drainage**



A Proud Member of



California Prop 65 Warning | To meet the requirements of California Proposition 65, it is our responsibility to inform you of the following: Warning Some products sold contain chemicals known to the state of California to cause cancer, birth defects, or other reproductive harm. For more information, please go to www.P65Warnings.ca.gov