



**NDS**®  
We put water in its place

Your knowledgeable and trusted partner for the best in water management solutions



Residential Stormwater Management | Commercial Stormwater Management | Professional Irrigation | Flow Management

2024 | 2025

# Product Catalog

[ndspro.com](https://ndspro.com)

MADE IN  
**USA**





## FITTINGS & CLAMPS



Our comprehensive line of sewer and drain fittings includes valves, couplings, and connectors in PVC and styrene. NDS continues its tradition of innovation with the new patent pending Swivel-Fit™ variable angle fitting that combines two fixed fittings into one adjustable fitting solution.

## SOLVENT-WELD SEWER & DRAIN FITTINGS

### Standards

PVC ASTM D-3034, D-2729

### Abbreviations

**Hub** = Hub Socket (receives pipe & Fitting SPT)

**Spt**= Spigot (pipe diameter, connect to fitting Hub)

**MPT** = Male Pipe Thread

**FPT** = Female Pipe Thread

**DWV** = Drain, Waste and Vent (Schedule 40 dimensions)

**S&D** = Sewer and Drain

**PVC** = Polyvinyl Chloride

**HIPS** = High-Impact Polystyrene



**One Adjustable Fitting for Any Job**

The patent-pending Swivel Fit® Variable Angle Fitting can be set to any angle from 0° to 90°. It is a convenient solution to tackle any job and is easy and less expensive than connecting multiple fixed angle fittings.

FITTINGS & CLAMPS

### Variable Angle Fittings

Patent Pending



Part No.	Description	Color	Pkg. Qty.	Wt. Ea. (lbs.)	Product Class
4PVAF	PVC S&D Swivel-Fit™ 0-90° Variable-Angled Fitting, 4 in. Hub X Hub	White	12	1.00	30PV

## SOLVENT-WELD SEWER & DRAIN FITTINGS

### Tee

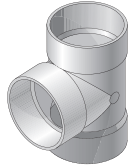

Part No.	Description	Color	Pkg. Qty.	Wt. Ea. (lbs.)	Product Class
3P01	PVC S&D Tee, 3 in. Hub X Hub X Hub	White	35	0.57	30PV
4P01	PVC S&D Tee, 4 in. Hub X Hub X Hub	White	20	0.95	30PV
6P01	PVC S&D Tee, 6 in. Hub X Hub X Hub	White	9	3.66	30PV
64P01	PVC S&D Tee, 6 in. Hub X Hub X 4 in. Hub	White	8	2.38	30PV
8P01	PVC S&D Tee, 8 in. Hub X Hub X Hub	White	2	3.00	30PV
84P01	PVC S&D Tee, 8 in. Hub X Hub X 4 in. Hub	White	7	4.72	30PV
86P01	PVC S&D Tee, 8 in. Hub X Hub X 6 in. Hub	White	3	5.00	30PV

### Double Cleanout

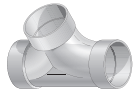

Part No.	Description	Color	Pkg. Qty.	Wt. Ea. (lbs.)	Product Class
417P	PVC S&D Double Cleanout, 4 in. Hub X Hub X Hub	White	24	1.41	30PV

### 90 Degree Elbow

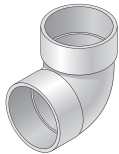

Part No.	Description	Color	Pkg. Qty.	Wt. Ea. (lbs.)	Product Class
3P02	PVC S&D 90° Elbow, 3 in. Hub X Hub	White	40	0.40	30PV
4P02	PVC S&D 90° Elbow, 4 in. Hub X Hub	White	25	0.68	30PV
6P02	PVC S&D 90° Elbow, 6 in. Hub X Hub	White	6	3.00	30PV
8P02	PVC S&D 90° Elbow, 8 in. Hub X Hub	White	4	6.50	30PV

### 90 Degree Long-Turn Elbow

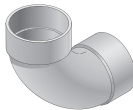

Part No.	Description	Color	Pkg. Qty.	Wt. Ea. (lbs.)	Product Class
31P0	PVC S&D 90° Long-Turn Elbow, 3 in. Hub X Hub	White	30	0.46	30PV
41P0	PVC S&D 90° Long-Turn Elbow, 4 in. Hub X Hub	White	20	0.85	30PV
61P0	PVC S&D 90° Long-Turn Elbow, 6 in. Hub X Hub	White	8	3.10	30PV

### 90 Degree Long-Turn Street Elbow

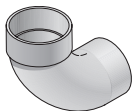

Part No.	Description	Color	Pkg. Qty.	Wt. Ea. (lbs.)	Product Class
31POST	PVC S&D 90° Long-Turn Street Elbow, 3 in. Hub X Spt	White	20	0.90	30PV
41POST	PVC S&D 90° Long-Turn Street Elbow, 4 in. Hub X Spt	White	20	1.25	30PV

### 45 Degree Elbow

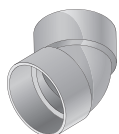

Part No.	Description	Color	Pkg. Qty.	Wt. Ea. (lbs.)	Product Class
3P03	PVC S&D 45° Elbow, 3 in. Hub X Hub	White	40	0.32	30PV
4P03	PVC S&D 45° Elbow, 4 in. Hub X Hub	White	30	0.53	30PV
6P03	PVC S&D 45° Elbow, 6 in. Hub X Hub	White	8	2.12	30PV
8P03	PVC S&D 45° Elbow, 8 in. Hub X Hub	White	6	4.33	30PV



## SOLVENT-WELD SEWER & DRAIN FITTINGS

### 45 Degree Street Elbow

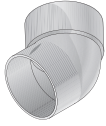

Part No.	Description	Color	Pkg. Qty.	Wt. Ea. (lbs.)	Product Class
3P03ST	PVC S&D 45° Street Elbow, 3 in. Hub X Spt	White	30	0.33	30PV
4P03ST	PVC S&D 45° Street Elbow, 4 in. Hub X Spt	White	30	0.86	30PV
6P03ST	PVC S&D 45° Street Elbow, 6 in. Hub X Spt	White	10	1.80	30PV

### 22-1/2 Degree Elbow

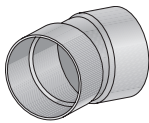

Part No.	Description	Color	Pkg. Qty.	Wt. Ea. (lbs.)	Product Class
3P04	PVC S&D 22.5° Elbow, 3 in. Hub X Hub	White	25	0.32	30PV
4P04	PVC S&D 22.5° Elbow, 4 in. Hub X Hub	White	20	0.45	30PV
6P04	PVC S&D 22.5° Elbow, 6 in. Hub X Hub	White	20	1.60	30PV

### Coupling



Part No.	Description	Color	Pkg. Qty.	Wt. Ea. (lbs.)	Product Class
3P05	PVC S&D Coupling, 3 in. Hub X Hub	White	120	0.22	30PV
4P05	PVC S&D Coupling, 4 in. Hub X Hub	White	45	0.37	30PV
6P05	PVC S&D Coupling, 6 in. Hub X Hub	White	10	1.30	30PV
8P05	PVC S&D Coupling, 8 in. Hub X Hub	White	6	3.33	30PV

### Slip Repair Coupling

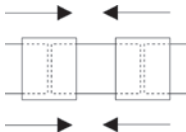

Part No.	Description	Color	Pkg. Qty.	Wt. Ea. (lbs.)	Product Class
3P05R	PVC S&D Slip Repair Coupling, 3 in. Hub X Hub	White	60	0.25	30PV
4P05R	PVC S&D Slip Repair Coupling, 4 in. Hub X Hub	White	45	0.46	30PV

### Increaser/Reducer Bushing



Part No.	Description	Color	Pkg. Qty.	Wt. Ea. (lbs.)	Product Class
3P07	PVC S&D Increaser/Reducer Bushing, 3 in. Hub X 4 in. Spt	White	20	0.45	30PV
6P07S	PVC S&D Increaser/Reducer Bushing, 4 in. Hub X 6 in. Spt	White	20	1.10	30PV

### Increaser/Reducer Coupling

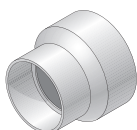

Part No.	Description	Color	Pkg. Qty.	Wt. Ea. (lbs.)	Product Class
4P07	PVC S&D Increaser/Reducer Coupling, 3 in. Hub X 4 in. Hub	White	30	0.36	30PV
6P07	PVC S&D Increaser/Reducer Coupling, 4 in. Hub X 6 in. Hub	White	20	1.10	30PV
8P07	PVC S&D Increaser/Reducer Coupling, 6 in. Hub X 8 in. Hub	White	1	3.00	30PV

## SOLVENT-WELD SEWER & DRAIN FITTINGS

### 45 Degree Wye

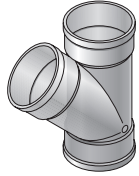

Part No.	Description	Color	Pkg. Qty.	Wt. Ea. (lbs.)	Product Class
3P08	PVC S&D 45° Wye, 3 in. Hub X Hub X Hub	White	25	0.88	30PV
4P08	PVC S&D 45° Wye, 4 in. Hub X Hub X Hub	White	20	1.25	30PV
6P08	PVC S&D 45° Wye, 6 in. Hub X Hub X Hub	White	6	4.66	30PV
64P08	PVC S&D 45° Wye, 6 in. Hub X Hub X 4 in. Hub	White	8	2.88	30PV
8P08	PVC S&D 45° Wye, 8 in. Hub X Hub X Hub	White	2	11.00	30PV
84P08	PVC S&D 45° Wye, 8 in. Hub X Hub X 4 in. Hub	White	6	5.33	30PV
86P08	PVC S&D 45° Wye, 8 in. Hub X Hub X 6 in. Hub	White	3	3.33	30PV

### Sanitary (Sweep) Tee



Part No.	Description	Color	Pkg. Qty.	Wt. Ea. (lbs.)	Product Class
3P09	PVC S&D Sanitary Tee, 3 in. Hub X Hub X Hub	White	30	0.66	30PV
4P09	PVC S&D Sanitary Tee, 4 in. Hub X Hub X Hub	White	20	1.60	30PV
6P09	PVC S&D Sanitary Tee, 6 in. Hub X Hub X Hub	White	5	4.20	30PV
8P09	PVC S&D Sanitary Tee, 8 in. Hub X Hub X Hub	White	1	15.00	30PV

### Cap

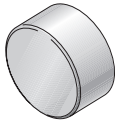

Part No.	Description	Color	Pkg. Qty.	Wt. Ea. (lbs.)	Product Class
3P06	PVC S&D Cap, 3 in. Hub	White	25	0.20	30PV
4P06	PVC S&D Cap, 4 in. Hub	White	25	0.28	30PV
6P06	PVC S&D Cap, 6 in. Hub	White	30	0.93	30PV
8P06	PVC S&D Cap, 8 in. Hub	White	10	2.40	30PV

### Female Cleanout Adapter



Part No.	Description	Color	Pkg. Qty.	Wt. Ea. (lbs.)	Product Class
3P11	PVC S&D Female Cleanout Adapter, 3 in. Hub X FPT	White	25	0.36	30PV
4P11	PVC S&D Female Cleanout Adapter, 4 in. Hub X FPT	White	20	0.55	30PV
613P	PVC S&D Female Cleanout Adapter, 6 in. Hub X FPT	White	24	1.08	30PV

### Female Fitting Cleanout Adapter



Part No.	Description	Color	Pkg. Qty.	Wt. Ea. (lbs.)	Product Class
413P	PVC S&D Female Fitting Cleanout Adapter, 4 in. Spt X FPT	White	20	0.50	30PV

### Cleanout Plug

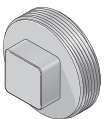

Part No.	Description	Color	Pkg. Qty.	Wt. Ea. (lbs.)	Product Class
31P8	PVC S&D Cleanout Plug, 3 in. MPT	White	50	0.30	30PV
41P8	PVC S&D Cleanout Plug, 4 in. MPT	White	30	0.36	30PV
61P8	PVC S&D Cleanout Plug, 6 in. MPT	White	24	0.62	30PV

## SOLVENT-WELD SEWER & DRAIN FITTINGS

### Swivel-Fit™ Variable-Angled Fitting

Patent Pending



Part No.	Description	Color	Pkg. Qty.	Wt. Ea. (lbs.)	Product Class
4PVAF	PVC S&D Swivel-Fit™ 0-90° Variable-Angled Fitting, 4 in. Hub X Hub	White	12	1.00	30PV

### Cross



Part No.	Description	Color	Pkg. Qty.	Wt. Ea. (lbs.)	Product Class
4P1X	PVC S&D Cross, 4 in. Hub X Hub X Hub X Hub	White	20	1.40	30PV

### Adapter (DWV/SCH40 to S&D)

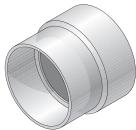

Part No.	Description	Color	Pkg. Qty.	Wt. Ea. (lbs.)	Product Class
3P15	PVC Adapter, 3 in. DWV/SCH40 Hub X S&D Hub	White	60	0.35	30PV
3P16	PVC Adapter, 4 in. DWV/SCH40 Hub X S&D Hub	White	30	0.80	30PV

### Adapter Bushing (DWV/SCH40 to S&D)



Part No.	Description	Color	Pkg. Qty.	Wt. Ea. (lbs.)	Product Class
2P41	PVC Adapter Bushing, 3 in. DWV/SCH40 Spt X S&D Hub	White	50	0.12	30PV
2P42	PVC Adapter Bushing, 4 in. DWV/SCH40 Spt X S&D Hub	White	25	0.24	30PV
2P43	PVC Adapter Bushing, 6 in. DWV/SCH40 Spt X S&D Hub	White	20	0.70	30PV

### Increaser/Reducer Adapter (DWV/SCH40 to S&D)

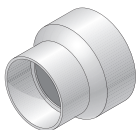

Part No.	Description	Color	Pkg. Qty.	Wt. Ea. (lbs.)	Product Class
533	PVC Increaser/Reducer Adapter, 2 in. DWV/SCH40 Hub X 4 in. S&D Spt	White	20	0.35	30PV
3P12	PVC Increaser/Reducer Adapter, 3 in. DWV/SCH40 Hub X 4 in. S&D Hub	White	50	0.50	30PV
3P17	PVC Increaser/Reducer Adapter, 3 in. DWV/SCH40 Hub X 4 in. S&D Spt	White	30	0.35	30PV

### Increaser/Reducer Adapter Bushing (DWV/SCH40 to S&D)



Part No.	Description	Color	Pkg. Qty.	Wt. Ea. (lbs.)	Product Class
532	PVC Increaser/Reducer Adapter Bushing, 2 in. DWV/SCH40 Hub X 3 in. S&D Spt	White	20	0.20	30PV

## SOLVENT-WELD SEWER & DRAIN FITTINGS

### Downspout Adapter for Sewer & Drain Pipe

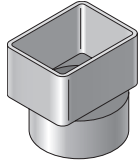

Part No.	Description	Color	Pkg. Qty.	Wt. Ea. (lbs.)	Product Class
9P03	PVC Offset Downspout Adapter, 2X3 in. Downspout X 3 in. S&D Hub	White	40	0.42	30PV
9P04	PVC Offset Downspout Adapter, 2X3 in. Downspout X 4 in. S&D Hub	White	30	0.53	30PV
9P06	PVC Downspout Adapter, 3X4 in. Downspout X 4 in. S&D Hub	White	25	0.50	30PV
9P10	PVC Offset Downspout Adapter, 4X6 in. Downspout X 6 in. S&D Hub	White	15	1.00	30PV
9P13	PVC Offset Downspout Adapter, 3X4 in. Downspout X 4 in. S&D Hub	White	25	0.50	30PV

### Downspout Adapter for DWV/Schedule 40 Pipe

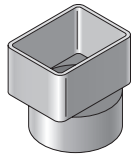

Part No.	Description	Color	Pkg. Qty.	Wt. Ea. (lbs.)	Product Class
9P07	PVC Downspout Adapter, 2X3 in. Downspout X 3 in. DWV/SCH40 Hub	White	40	0.30	30PV
9P08	PVC Downspout Adapter, 2X3 in. Downspout X 4 in. DWV/SCH40 Hub	White	30	1.10	30PV
9P09	PVC Downspout Adapter, 3X4 in. Downspout X 4 in. DWV/SCH40 Hub	White	30	0.44	30PV

## POOL ACCESSORIES

### Drain Grate



Part No.	Description	Color	Pkg. Qty.	Wt. Ea. (lbs.)	Product Class
9P12	3 in. PVC Round Grate, Fits 3 in. Sewer & Drain Fittings	White	50	0.16	30PV
9P11	4 in. PVC Round Grate, Fits 4 in. Sewer & Drain Fittings	White	25	0.36	30PV

### Deck Drain



Part No.	Description	Color	Pkg. Qty.	Wt. Ea. (lbs.)	Product Class
WC100	HIPS S&D Deck Drain, 3 in. Hub	White	50	0.16	30ST
WC100G	HIPS S&D Deck Drain, 3 in. Hub	Gray	50	0.16	30ST
WC100T	HIPS S&D Deck Drain, 3 in. Hub	Tan	50	0.16	30ST

### Pool Backflush Fitting

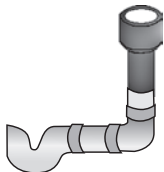

Part No.	Description	Color	Pkg. Qty.	Wt. Ea. (lbs.)	Product Class
650	HDPE Pool Backflush Fitting with Recessed Grate, 4 in. tapered Spt (Includes removable 4" grate NDS #11)	Black	35	0.16	30ST



## CORRUGATED FITTINGS

### Coupling



Part No.	Description	Color	Pkg. Qty.	Wt. Ea. (lbs.)	Product Class
3C05	HDPE Internal Coupling, 3 in.	Black	60	0.30	11RP
4C07	HDPE Internal Coupling, 4 in.	Black	36	0.30	11RP
6C05	HDPE Internal Coupling, 6 in.	Black	12	0.80	11RP

### End Cap



Part No.	Description	Color	Pkg. Qty.	Wt. Ea. (lbs.)	Product Class
3C06	HDPE End Cap, 3 in.	Black	33	0.30	11RP
4C06	HDPE End Cap, 4 in.	Black	32	0.50	11RP
6C06	HDPE End Cap, 6 in.	Black	15	0.50	11RP

### Adapter

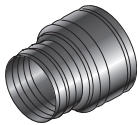

Part No.	Description	Color	Pkg. Qty.	Wt. Ea. (lbs.)	Product Class
351	HDPE Corrugated Adapter, 3 in. Drain Pipes & Fittings Spt X 3 in. Corr. Hub	Black	50	0.10	30PV
451	HDPE Corrugated Adapter, 4 in. Drain Pipes & Fittings Spt X 4 in. Corr. Hub	Black	25	0.20	30PV
651	HDPE Corrugated Adapter, 6 in. Drain Pipes & Fittings Spt X 6 in. Corr. Hub	Black	12	0.25	30PV

### Downspout Adapter



Part No.	Description	Color	Pkg. Qty.	Wt. Ea. (lbs.)	Product Class
234CDS	HDPE Downspout Adapter, 2X3 in. Downspout X 4 in. Corr. Hub	Black	24	0.20	30ST
344CDS	HDPE Downspout Adapter, 3X4 in. Downspout X 4 in. Corr. Hub	Black	24	0.20	30ST

# DIVERTER AND BACKWATER VALVES

## Diverter Valve

Here's the simplest, strongest and most economical diverter valve ever invented for septic tank leach fields. It is made of tough molded plastic that will not shatter, bend, rust or corrode. It is lighter in weight, easier to handle and less expensive to ship.

### Functional

The diverter valve stem flow may be controlled to individual or multiple fields (up to three) in any combination. With a three-way valve stem, flow may be diverted to any two outlets. To allow flow through all outlets, the valve stem may be removed from the assembly.

### Easy to Install

Connect 4" plastic sewer and drain pipe to inlets and outlets on the four-way distribution box. (Unwanted outlets may be sealed by installing caps.) The diverter shield which houses the diverter stem may be cut to desired length.

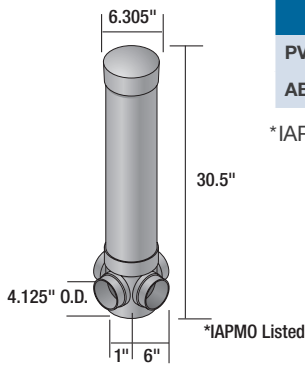

	Part No.	Description	Color	Pkg. Qty.	Wt. Ea. (lbs.)	Product Class
PVC	575P	4" PVC Diverter Valve	White	4	9.50	35PV
ABS*	575	4" ABS Diverter Valve	Black	4	7.50	35AB

\*IAPMO Listed.

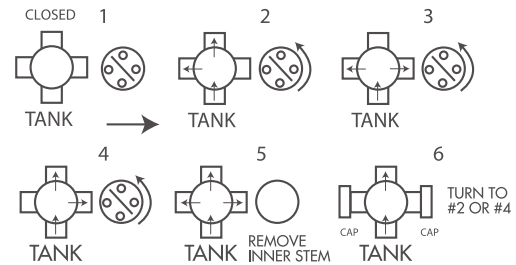

## Gravity Backwater Valve

The NDS gravity flow Backwater Valve is designed to protect low areas or basements from the backflow of waste from street sewers. It is available in 2", 3", 4" and 6" sizes, PVC material. It is a cost-effective and a chemically resistant alternative to cast iron valves.

### Backwater Valve

The quick action flapper allows unrestricted uni-directional flow. Elastomeric gasket in the flapper ensures a watertight seal. Flapper can be easily removed and replaced if required. Threaded access cap is designed for hand tightening. Access cap neoprene gasket provides a positive seal. Valve hub outlets fit 2", 3", 4" or 6" DWV pipe and may be adapted to 2", 3", 4" or 6" sewer and drain pipe with NDS DWV to Sewer & Drain Adapters. Lightweight, easy to install. Horizontal installation required, with arrows on top of the valve hub pointing in the direction of the flow of water. Access riser with cover offers a simple, economical access to the valve for inspection and maintenance. The riser may be cut to the desired length.

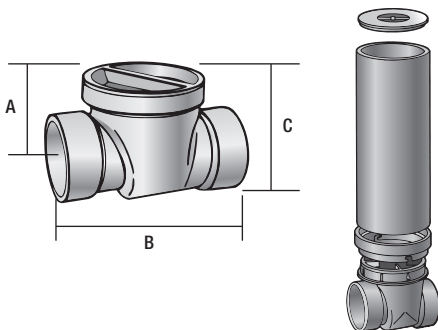

Item Number	A	B	C	Riser Height	Riser Diameter
275P, 275	2.18"	5.03"	3.53"	16"	4"
375P, 375	3.51"	7.56"	6.10"	16"	6"
375PR	3.51"	7.56"	6.10"	16"	6"
475P, 475	4.47"	11.18"	7.18"	16"	8"
475PR	4.47"	11.18"	7.18"	16"	8"
675P, 675	5.50"	15.25"	9.90"	16"	10"

Approvals applicable to valve only.



## DIVERTER AND BACKWATER VALVES

### Backwater Valve

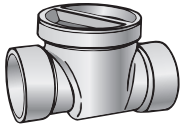

Part No.	Description	Color	Pkg. Qty.	Wt. Ea. (lbs.)	Product Class
275P	2" PVC Backwater Valve	White	8	1.00	35PV
375P	3" PVC Backwater Valve	White	6	2.33	35PV
375PR	3" PVC Backwater Valve with Riser and Cover	White	1	5.00	35PV
475P	4" PVC Backwater Valve	White	6	4.33	35PV
475PR	4" PVC Backwater Valve with Riser and Cover	White	1	8.00	35PV
675P	6" PVC Backwater Valve	White	1	9.00	35PV
275	2" ABS Backwater Valve	Black	8	1.00	35AB
375	3" ABS Backwater Valve	Black	6	1.83	35AB
475	4" ABS Backwater Valve	Black	6	3.33	35AB
675	6" ABS Backwater Valve and Cover	Black	1	7.00	35AB

### PVC Backwater Valve Components

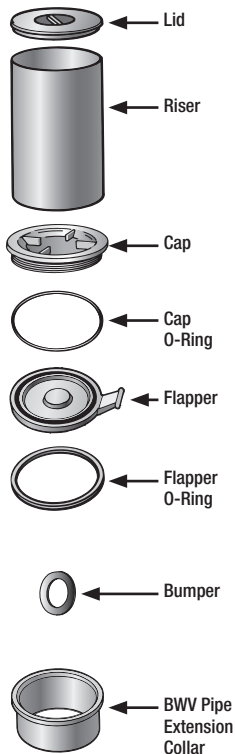

Part No.	Description	Color	Carton Qty.	Product Class
822-040-16	2" Riser	White	4	35PV
1530202	2" Cap	White	10	35PV
880-136	2" Flapper O-Ring	Black	10	35PV
1530204	2" Backwater Valve Pipe Extension Collar	White	10	35PV
8051-030-060	3" Lid	White	25	35PV
880-253	3" Cap O-Ring	Black	10	35PV
1530303	3" Flapper	White	10	35PV
880-234	3" Flapper O-Ring	Black	10	35PV
1530304	3" Backwater Valve Pipe Extension Collar	White	10	35PV
8051-040-080	4" Lid	White	20	35PV
822-080-16	4" Riser	White	1	35PV
880-364	4" Cap O-Ring	Black	10	35PV
880-243	4" Flapper O-Ring	Black	10	35PV
8051-060-100	6" Lid	White	15	35PV
1530602	6" Cap	White	2	35PV
880-271	6" Cap O-Ring	Black	2	35PV
1530603	6" Flapper	White	5	35PV
880-259	6" Flapper O-Ring	Black	5	35PV
880-202	Bumper (fits all sizes of valves)	Black	1	35PV
1530605	6" BWV Sewer Adapt Flange	White	1	35PV

### Backwater Valve Box

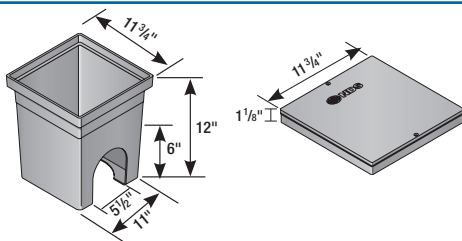

Part No.	Description	Color	Pkg. Qty.	Wt. Ea. (lbs.)	Product Class
1219	12" x 12" Backwater Valve Box	Black	4	5.75	10ND
1220	12" x 12" Valve Box Cover	Black	8	2.00	10ND

# NDS FLEXIBLE COUPLINGS AND CONNECTORS

- Choose the high-quality couplings and connectors that easily adapt to any situation
- Innovative, flexible couplings for sewer, drain, waste and vent piping allow any two pipes to be connected quickly and easily
- Dimensional flexibility ensures leakproof seals with virtually any pipe material
- Utility and plumbing applications

## Details

- Couplings and connectors fit over the ends of plain-end or spigot pipe to form a positive seal against infiltration and exfiltration in non-pressure environments
- Durable PVC construction allows couplings to flex with normal earth movement
- Completely unaffected by soil conditions and resistant to chemicals, UV rays and normal sewer gases

## Materials and Standards

- Flexible couplings are made of elastomeric polyvinyl chloride (PVC) for long-lasting performance and durability
- Bactericides and fungicides are added to PVC for extra protection
- All NDS clamps, including the band and housing, are made from series 300 stainless steel, offering corrosion-resistant, rustproof reliability
- NDS Flexible Couplings have listings from the following code agencies: ICC (International Code Council), CSA (Canadian Standards Association) and IAPMO (International Association of Plumbing and Mechanical Officials)

## Installation

- Clamps install easily with a screwdriver, 5/16" nut driver or socket to 60 inch-lbs. pounds torque
- All couplings are marked with size and pipe materials that the coupling will connect, eliminating guesswork on the job

## NDS Flexible Coupling Sizing Chart

FITTINGS & CLAMPS

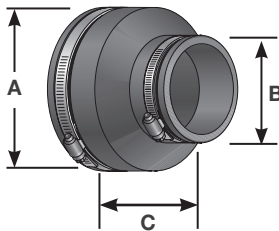

- All dimensions given in inches and mm.
- Couplings available to connect 1-1/4" to 15" pipe.
- 300 Series stainless steel clamps supplied with all couplings.
- All couplings will fit any pipe type within +/- 5% OD on chart.

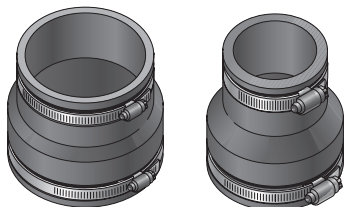

### Clay to Clay

Part No.	A		B		C		Pkg. Qty.	Weight	Product Class
	Inches	mm	Inches	mm	Inches	mm			
01-44	5.25	133	5.25	133	4.00	101	18	1.27	45C0

### Clay to Cast Iron or Plastic

Part No.	A		B		C		Pkg. Qty.	Weight	Product Class
	Inches	mm	Inches	mm	Inches	mm			
02-43	5.25	133	3.38	85	4.00	101	36	1.25	45C0
02-44	5.25	133	4.38	111	4.00	101	24	1.04	45C0
02-55	USE PART NO. 56-65								
02-64	7.38	187	4.38	111	6.00	152	12	2.50	45C0
02-66	7.38	187	6.38	162	6.00	152	18	2.38	45C0
02-88	9.65	245	8.50	215	6.00	152	6	3.16	45C0

### Concrete to Cast Iron or Plastic

Part No.	A		B		C		Pkg. Qty.	Weight	Product Class
	Inches	mm	Inches	mm	Inches	mm			
06-44	5.62	142	4.38	111	4.00	101	18	1.66	45C0
06-64	7.80	198	4.38	111	6.00	152	12	2.41	45C0
06-66	7.80	198	6.38	162	6.00	152	12	2.58	45C0
06-88	10.25	260	8.50	215	6.00	152	6	3.33	45C0



## NDS FLEXIBLE COUPLINGS AND CONNECTORS

### NDS Flexible Coupling Sizing Chart

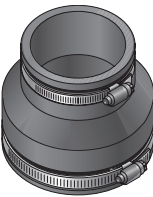
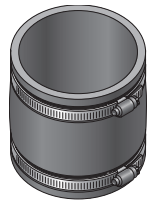
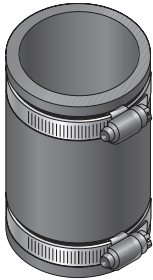

#### Asbestos Cement, Fibre or Ductile Iron to Cast Iron or Plastic

Part No.	A		B		C		Pkg. Qty.	Weight	Product Class
	Inches	mm	Inches	mm	Inches	mm			
51-44	4.75	120	4.38	111	4.00	101	24	1.08	45CO
51-66	7.00	177	6.38	162	6.00	152	15	2.73	45CO

#### Cast Iron, Plastic, Copper, Steel or Lead to Cast Iron, Plastic, Copper, Steel or Lead

Part No.	A		B		C		Pkg. Qty.	Weight	Product Class
	Inches	mm	Inches	mm	Inches	mm			
56-125	1.65	40	1.65	40	4.00	101	90	0.36	45CO
56-150/125	1.90	48	1.65	40	4.00	101	75	0.41	45CO
56-150	1.90	48	1.90	48	4.00	101	75	0.41	45CO
56-2150	2.40	60	1.90	48	4.00	101	54	0.51	45CO
56-22	2.40	60	2.40	60	4.00	101	54	0.50	45CO
56-32	3.38	85	2.40	60	4.00	101	45	0.71	45CO
56-33	3.38	85	3.38	85	4.00	101	45	0.75	45CO
56-42	4.38	111	2.40	60	4.00	101	30	0.93	45CO
56-E43	4.38	111	3.38	85	4.00	101	24	1.37	45CO
56-43	4.38	111	3.38	85	4.00	101	25	1.08	45CO
56-44	4.42	112	4.42	112	4.00	101	24	1.66	45CO
56-E64	6.38	162	4.38	111	6.00	152	10	2.20	45CO
56-64	6.38	162	4.38	111	6.00	152	12	2.16	45CO
56-66	6.38	162	6.38	162	6.00	152	15	2.13	45CO
56-86	8.50	215	6.38	162	6.00	152	8	3.37	45CO
56-88	8.50	215	8.50	215	6.00	152	12	3.50	45CO
56-1010	10.60	269	10.60	269	7.00	178	2	6.00	45CO
56-1212	12.83	326	12.83	326	6.00	152	3	5.00	45CO

## NDS FLEXIBLE COUPLING SIZING CHART

### Drain and Trap Connectors

NDS Drain & Trap Connectors are ideal for new installation, alterations and repairs. These connectors offer a quick, low-cost alternative to gluing or soldering and eliminate the need for special tools or threading. Simply place the ends over the pipes and tighten the stainless steel clamps.

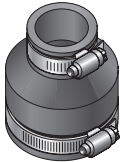

Part No.	Description	Color	Pkg. Qty.	Wt. Ea. (lbs.)	Product Class
57-125	1-1/4" or 1-1/2" Drain Piping x 1-1/4" or 1-1/2" Drain Piping	Black	180	0.17	45C0
57-150/125	1-1/2" DWV or 1-1/2" Copper x 1-1/4" or 1-1/2" Drain Piping	Black	120	0.25	45C0

### Large Diameter Couplings

Large Diameter Couplings are available through NDS. The large couplings are engineered for use with all the common pipe material: clay, concrete, cast iron, plastic, fiberglass, ductile iron and asbestos/cement. When ordering please remember to provide the exact O.D. size in inches for both pipes. A difference of 6" between the two pipe O.D. sizes cannot be made. Please call for details 1-800-726-1994.

### Expansion Joints

NDS Flexible Expansion Joints have a one-piece design which allows for the thermal contraction and expansion of drain, waste and vent. These couplings are maintenance free and rustproof. They are secured by series 300 stainless steel clamps. NDS expansion joints are made of tough elastomeric polyvinyl chloride (PVC). They are strong and resilient. Available in 2" and 3" sizes.

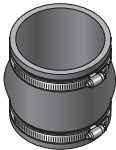
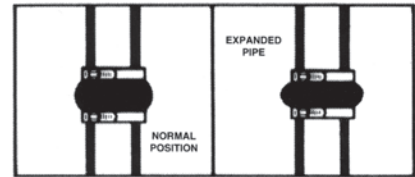

Part No.	Description	Color	Pkg. Qty.	Wt. Ea. (lbs.)	Product Class
XJ3	3" Expansion Joints	Black	24	0.67	45C0

#### Clamps for Flexible Couplings

CLAMP MIN. & MAX. DIAMETERS & OVERALL LENGTH							
Part No.	Max. Dia.	Min. Dia.	Length	Color	Weight	Pkg. Qty.	Product Class
33H040 CLAMP	3.00"	2.06"	10-3/8"	Stainless Steel	0.05	400	45C0
33H250 CLAMP	12.62"	8.75"	40-1/2"	Stainless Steel	0.25	100	45C0
33S248 CLAMP	16"	3.625"	51-1/2"	Stainless Steel	0.25	100	45FS

## NDS CONNECTORS

NDS Connectors for sewer pipe joints and drain waste & vent piping allow several points of seal between most types of sockets, hubs, bells and spigots. NDS Connectors are donut-shaped rings made of tough elastomeric polyvinyl chloride (PVC) and are available in a range of sizes up to 6". They install quickly and easily and offer the dimensional flexibility that ensures leakproof seals. They are also resistant to chemicals, fungus growth and normal sewer gases due to the inert nature and physical properties of the material.

*NOTE: Connectors may not perform as intended due to improper or insufficient description of the pipes being connected or changes in pipe dimensions or design by the various manufacturers.*

### SV Cast Iron Connectors



Part No.	Description	Color	Pkg. Qty.	Wt. Ea. (lbs.)	Product Class
44U-405	4" x 4" SV HUB x Sch40 (DWW) or Sch40 Steel or C.I.XH	Black	35	0.48	45C0

### Asbestos Cement Connectors – John Manville and Capco



Part No.	Description	Color	Pkg. Qty.	Wt. Ea. (lbs.)	Product Class
44U-405	4" x 4" SW Duplex Adapter x C.I.XH or ABS/PVC DWW	Black	35	0.48	45C0

## CONCRETE MANHOLE COVER ADAPTERS

NDS Concrete Manhole Cover Adapters are made of elastomeric polyvinyl chloride (PVC) and are available for 4", 6", and 8" pipe. Our adapters help eliminate leaks around pipe entering manhole walls and are flexible enough to permit some lateral pipe movement without compromising the integrity of the seal. However, NDS does not warrant this product as a positive water seal due to the many varying factors that can influence the product's effectiveness as a positive seal, such as: field conditions, quality of grout, workmanship and high-ground water tables.

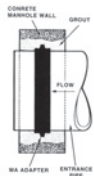

Part No.	Description	Color	Pkg. Qty.	Wt. Ea. (lbs.)	Product Class
4MA	4" Manhole Adapter	Black	24	1.00	45C0
6MA	6" Manhole Adapter	Black	24	0.62	45C0
8MA	8" Manhole Adapter	Black	14	1.00	45C0

## NDS FLEXIBLE SADDLES

For superior durability and flexibility, saddle up. A breakthrough in saddle design, the patented NDS Flexible Saddle demonstrates superior flexibility in more than one way. The saddle's elastomeric construction allows a single description to securely fit 6" sewer main pipe diameters and up. The saddle's flexibility eliminates the need for a large inventory of rigid PVC saddles of various descriptions.

NDS Flexible Saddle offers the following product benefits:

- Two configurations, a "Tee" and a "Wye" are available in 4" or 6" inlet descriptions
- Elastomeric construction provides maximum strength and flexibility
- Saddle design will accommodate polyethylene pipe used in slip lining sewer systems
- Inlet range from SCH-40 down to SDR-35 includes standard weight soil pipe
- Stainless steel series 300 clamps ensure tight seal
- Steel-reinforced edges prevent distortion when torque is applied to clamps
- Durable design and low unit price make the Flexible Saddle economical and environmentally wise
- Available saddle blanket, attached to pipe prior to saddle installation, will mend imperfections and cracks on clay pipe taps

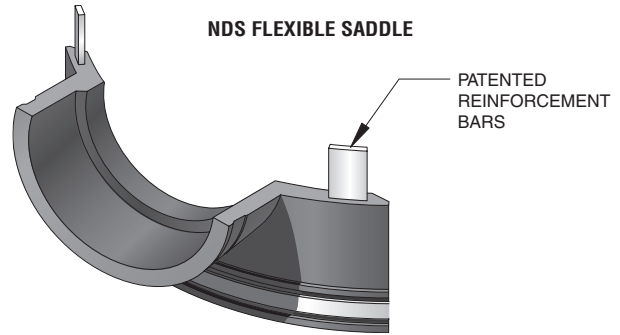

## NDS Flexible Saddles

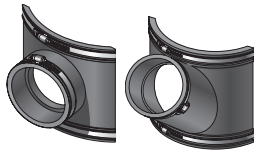

Part No.	Description	Color	Pkg. Qty.	Wt. Ea. (lbs.)	Product Class
4T/C	4" Tees with Clamps	Black	12	3.16	45FS
4T/WOC	4" Tees without Clamps	Black	12	2.66	45FS
4Y/C	4" Wyes with Clamps	Black	6	7.66	45FS
4Y/WOC	4" Wyes without Clamps	Black	6	7.12	45FS
6T/C	6" Tees with Clamps	Black	6	6.50	45FS
6T/WOC	6" Tees without Clamps	Black	6	6.0	45FS
6Y/C	6" Wyes with Clamps	Black	4	9.9	45FS
6Y/WOC	6" Flex Wye without Clamps	Black	4	11.75	45FS

## Saddle Clamps

Part No.	Description	Color	Pkg. Qty.	Wt. Ea. (lbs.)	Product Class
33S248 CLAMP	Clamp for Flexible Coupling	Stainless Steel	100	0.25	45FS

### ASTM Material Specification

Test	NDS Material	ASTM Test Material
Chemical Resistance		
1N sulfuric acid	No weight loss	D543
1N hydrochloric acid	No weight loss	
Tensile Strength Elongation	1000 psi (7/Mpa) min. 200% min. elongation @ break	D412 Die "C"
Duration Hardness	Shore durometer 50 min. to 75 max.	D2240
Compression Set	30% max. of original deflection	D395, Method B Type 2
Water Absorption	5% max.	D471, immersed 7 days @158 Method A
Ozone Resistance	No visible cracking under 7x magnification	D1149, D518 Method A
Oven Aging	75% min. of original tensile strength 65% min. of original elongation	D573 (158°F for 70 hours)
Cold Brittleness	Cold brittleness was determined to be -43°C	D476
Tear Strength	125 lbs./in.	D624 Die "C"



## CLAMPS

### Stainless Steel Pinch "Crimp" Hose Clamps



Part No.	Description	Pkg. Qty.	Case. Qty.	Product Class
NC-155000-009	170R SS Crimp Clamp	100	100	45PC
NC-155000-010	185R 23/32" SS Crimp Clamp	100	3000	45PC
NC-155000-011	198R 5/8" SS Crimp Clamp	100	3000	45PC
NC-155000-012	210R 13/16" SS Crimp Clamp	100	2500	45PC
NC-155000-013	226R SS Crimp Clamp	100	100	45PC
NC-155000-015	256R 3/4" SS Crimp Clamp	100	100	45PC
NC-155000-016	271R 3/4" SS Crimp Clamp	100	2000	45PC
NC-155000-019	316R 15/16" SS Crimp Clamp	100	2000	45PC
NC-155000-020	331R 1" SS Crimp Clamp	100	2000	45PC
NC-155000-021	346R 1-3/8" SS Crimp Clamp	100	1500	45PC
NC-155000-027	425R 1-1/4" SS Crimp Clamp	80	1500	45PC
NC-155000-031	485R 1-7/8" SS Crimp Clamp	50	1500	45PC

### Stainless Steel Pinch Clamp Crimp Tool



Part No.	Description	Pkg. Qty.	Carton Qty.	Product Class
NCT-1098	Standard Jaw Crimp Tool	1	10	45PC

# CLAMPS

## Worm Drive Hose Clamps



**Superior Longevity** – 100% stainless steel construction

**Added Strength** – 4 piece design includes underside plate, Conical arched perforated slots

**Smoother Worm Drive** – Buttressed threads and more threads per screw

Primarily use to tighten around and secure pliable (soft) hose or tube

Plumbing: Connections for dishwashers, garbage disposals, water softeners, air conditioning

Irrigation: Secure poly tubing, stabilize risers to stake

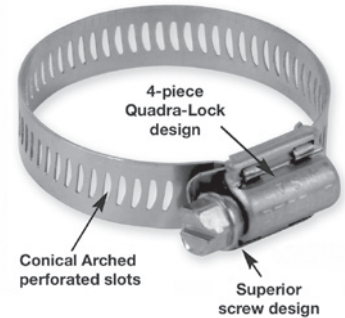

FITTINGS & CLAMPS

Part No.	Description	Pkg. Qty.	Case. Qty.	Product Class
3604	SAE 6, 5/16" Band Width, Effective Diameter Range: 7/16" Min., 25/32" Max.	10	200	45HC
3606	SAE 8, 5/16" Band Width, Effective Diameter Range: 1/2" Min., 29/32" Max.	10	200	45HC
64006H	SAE 6, 1/2" Band Width, Effective Diameter Range: 7/16" Min., 25/32" Max.	10	200	45HC
64008H	SAE 8, 1/2" Band Width, Effective Diameter Range: 1/2" Min., 29/32" Max.	10	200	45HC
64010H	SAE 10, 1/2" Band Width, Effective Diameter Range: 9/16" Min., 1-1/6" Max.	10	500	45HC
64012H	SAE 12, 1/2" Band Width, Effective Diameter Range: 11/16" Min., 1-1/4" Max.	10	500	45HC
64016H	SAE 16, 1/2" Band Width, Effective Diameter Range: 13/16" Min., 1-1/2" Max.	10	500	45HC
64020H	SAE 20, 1/2" Band Width, Effective Diameter Range: 13/16" Min., 1-3/4" Max.	10	500	45HC
64024H	SAE 24, 1/2" Band Width, Effective Diameter Range: 1-1/16" Min., 2" Max.	10	500	45HC
64028H	SAE 28, 1/2" Band Width, Effective Diameter Range: 1-5/16" Min., 2-1/4" Max.	10	500	45HC
64032H	SAE 32, 1/2" Band Width, Effective Diameter Range: 1-9/16" Min., 2-1/2" Max.	10	500	45HC
64036H	SAE 36, 1/2" Band Width, Effective Diameter Range: 1-13/16" Min., 2-3/4" Max.	10	500	45HC
64040H	SAE 40, 1/2" Band Width, Effective Diameter Range: 2-1/16" Min., 3" Max.	10	200	45HC
64044H	SAE 44, 1/2" Band Width, Effective Diameter Range: 2-5/16" Min., 3-1/4" Max.	10	200	45HC
64048H	SAE 48, 1/2" Band Width, Effective Diameter Range: 2-9/16" Min., 3-1/2" Max.	10	200	45HC
64052H	SAE 52, 1/2" Band Width, Effective Diameter Range: 2-13/16" Min., 3-3/4" Max.	10	200	45HC
64056H	SAE 56, 1/2" Band Width, Effective Diameter Range: 3-1/16" Min., 4" Max.	10	200	45HC
64064H	SAE 62, 1/2" Band Width, Effective Diameter Range: 3-9/16" Min., 4-1/2" Max.	10	200	45HC
64072H	SAE 72, 1/2" Band Width, Effective Diameter Range: 1-7/8" Min., 5" Max.	10	100	45HC
64080H	SAE 80, 1/2" Band Width, Effective Diameter Range: 2-1/2" Min., 5-1/2" Max.	10	100	45HC
64088H	SAE 88, 1/2" Band Width, Effective Diameter Range: 3-1/8" Min., 6" Max.	10	100	45HC
64096H	SAE 96, 1/2" Band Width, Effective Diameter Range: 3-5/8" Min., 6-1/2" Max.	10	100	45HC
64104H	SAE 104, 1/2" Band Width, Effective Diameter Range: 4-1/8" Min., 7" Max.	10	100	45HC

## CLAMPS

### Worm Drive Hose Clamps (cont.)



Part No.	Description	Pkg. Qty.	Case. Qty.	Product Class
200 06 H	SAE 6, 9/16" Band Width, Effective Diameter Range: 7/16" Min., 25/32" Max.	10	200	45HC
200 08 H	SAE 8, 9/16" Band Width, Effective Diameter Range: 1/2" Min., 29/32" Max.	10	200	45HC
200 10 H	SAE 10, 9/16" Band Width, Effective Diameter Range: 9/16" Min., 1-1/6" Max.	10	500	45HC
200 12 H	SAE 12, 9/16" Band Width, Effective Diameter Range: 11/16" Min., 1-1/4" Max.	10	500	45HC
200 16 H	SAE 16, 9/16" Band Width, Effective Diameter Range: 13/16" Min., 1-1/2" Max.	10	500	45HC
200 20 H	SAE 20, 9/16" Band Width, Effective Diameter Range: 13/16" Min., 1-3/4" Max.	10	500	45HC
200 24 H	SAE 24, 9/16" Band Width, Effective Diameter Range: 1-1/16" Min., 2" Max.	10	500	45HC
200 28 H	SAE 28, 9/16" Band Width, Effective Diameter Range: 1-5/16" Min., 2-1/4" Max.	10	500	45HC
200 32 H	SAE 32, 9/16" Band Width, Effective Diameter Range: 1-9/16" Min., 2-1/2" Max.	10	500	45HC
200 36 H	SAE 36, 9/16" Band Width, Effective Diameter Range: 1-13/16" Min., 2-3/4" Max.	10	500	45HC
200 40 H	SAE 40, 9/16" Band Width, Effective Diameter Range: 2-1/16" Min., 3" Max.	10	200	45HC
200 44 H	SAE 44, 9/16" Band Width, Effective Diameter Range: 2-5/16" Min., 3-1/4" Max.	10	200	45HC
200 52 H	SAE 52, 9/16" Band Width, Effective Diameter Range: 2-13/16" Min., 3-3/4" Max.	10	200	45HC
200 56 H	SAE 56, 9/16" Band Width, Effective Diameter Range: 3-1/16" Min., 4" Max.	10	200	45HC
200 64 H	SAE 62, 9/16" Band Width, Effective Diameter Range: 3-9/16" Min., 4-1/2" Max.	10	200	45HC
200 72 H	SAE 72, 9/16" Band Width, Effective Diameter Range: 1-7/8" Min., 5" Max.	10	100	45HC
200 80 H	SAE 80, 9/16" Band Width, Effective Diameter Range: 2-1/2" Min., 5-1/2" Max.	10	100	45HC
200 88 H	SAE 88, 9/16" Band Width, Effective Diameter Range: 3-1/8" Min., 6" Max.	10	100	45HC
200 96 H	SAE 96, 9/16" Band Width, Effective Diameter Range: 3-5/8" Min., 6-1/2" Max.	10	100	45HC
200 104 H	SAE 104, 9/16" Band Width, Effective Diameter Range: 4-1/8" Min., 7" Max.	10	100	45HC
200 128 H	SAE 128, 9/16" Band Width, Effective Diameter Range: 5-5/8" Min., 8-1/2" Max.	10	100	45HC
200 152 H	SAE 152, 9/16" Band Width, Effective Diameter Range: 7-1/8" Min., 10" Max.	10	100	45HC
200 188 H	SAE 188, 9/16" Band Width, Effective Diameter Range: 9-3/8" Min., 12-1/4" Max.	10	100	45HC
200 212 H	SAE 212, 9/16" Band Width, Effective Diameter Range: 10-7/8" Min., 13-3/4" Max.	10	100	45HC

## CLAMPS

### Clamp-All® Hi-Torq Hubless Pipe Couplings



Part No.	Size	Description	Carton Qty.	Weight (lbs.)	Product Class
81015	1-1/2"	Hi-Torq 80 Couplings	80	34	45CA
81020	2"	Hi-Torq 80 Couplings	64	31	45CA
81030	3"	Hi-Torq 80 Couplings	36	23	45CA
81040	4"	Hi-Torq 80 Couplings	36	28	45CA
81050	5"	Hi-Torq 80 Couplings	12	17	45CA
81060	6"	Hi-Torq 80 Couplings	12	20	45CA
81080	8"	Hi-Torq 80 Couplings	8	16	45CA
81100	10"	Hi-Torq 80 Couplings	8	21	45CA
10015	1-1/2"	Hi-Torq 125 Couplings	80	41	45CA
10020	2"	Hi-Torq 125 Couplings	64	38	45CA
10030	3"	Hi-Torq 125 Couplings	36	28	45CA
10040	4"	Hi-Torq 125 Couplings	36	34	45CA
10050	5"	Hi-Torq 125 Couplings	12	21	45CA
10060	6"	Hi-Torq 125 Couplings	12	24	45CA
10080	8"	Hi-Torq 125 Couplings	8	22	45CA
10100	10"	Hi-Torq 125 Couplings	8	25	45CA
10120	12"	Hi-Torq 125 Couplings	8	34	45CA
10150	15"	Hi-Torq 125 Couplings	4	23	45CA

### Clamp-All® Tools



Part No.	Size	Description	Carton Qty.	Product Class
99080	80	Hi-Torq 80 wrench	1	45CA
99125	125	Hi-Torq 125 wrench	1	45CA

### Snap-All® Increaser/Reducer Transition Bushings



Part No.	Description	Carton Qty.	Weight (lbs.)	Product Class
31575	1-1/2" x 3/4" CU	12/144	29	45CA
30151	1-1/2" x 1" CU	12/144	23	45CA
31512	1-1/2" x 1-1/4" CU	12/144	15	45CA
31515	1-1/2" x 1-1/2" CU	12/144	12	45CA
30215	2" x 1-1/2" CU	6/72	15	45CA
20215	2" x 1-1/2" CI, STL, PVC	6/72	10	45CA
30022	2" x 2" CU, XH	6/72	7	45CA
30032	3" x 2" CU	9/108	50	45CA
30043	4" x 3" CU	5/60	40	45CA
20043	4" x 3" CI, STL, PVC	5/60	34	45CA
30044	4" x 4" CU, XH	5/60	13	45CA
20054	5" x 4" CI, STL, PVC	4/48	40	45CA
20065	6" x 5" CI, STL, PVC	1/12	14	45CA
20086	8" x 6" CI, STL, PVC	1/12	34	45CA



## FITTINGS & CLAMPS PRODUCTS INDEX

Part No.	Page	Part No.	Page	Part No.	Page	Part No.	Page	Part No.	Page
01-44	178	6P07	171	84P01	170	3604	184	1530304	177
02-43	178	6P07S	171	84P08	172	3606	184	1530602	177
02-44	178	6P08	172	86P01	170	8051-030-060	177	1530603	177
02-55	178	6P09	172	86P08	172	8051-040-080	177	1530605	177
02-64	178	6T/C	182	200	185	8051-060-100	177	NC-155000-009	183
02-66	178	6T/WOC	182	200 06 H	185	10015	186	NC-155000-010	183
02-88	178	6Y/C	182	200 10 H	185	10020	186	NC-155000-011	183
2P41	173	6Y/WOC	182	200 12 H	185	10030	186	NC-155000-012	183
2P42	173	8MA	181	200 16 H	185	10040	186	NC-155000-013	183
2P43	173	8P01	170	200 20 H	185	10050	186	NC-155000-015	183
3C05	175	8P02	170	200 24 H	185	10060	186	NC-155000-016	183
3C06	175	8P03	170	200 28 H	185	10080	186	NC-155000-019	183
3P01	170	8P05	171	200 32 H	185	10100	186	NC-155000-020	183
3P02	170	8P06	172	200 36 H	185	10120	186	NC-155000-021	183
3P03	170	8P07	171	200 40 H	185	10150	186	NC-155000-027	183
3P03ST	171	8P08	172	200 44 H	185	20043	186	NC-155000-031	183
3P04	171	8P09	172	200 52 H	185	20054	186	NCT-1098	183
3P05	171	9P03	174	200 56 H	185	20065	186	WC100	174
3P05R	171	9P04	174	200 64 H	185	20086	186	WC100G	174
3P06	172	9P06	174	200 72 H	185	20215	186	WC100T	174
3P07	171	9P07	174	200 80 H	185	30022	186	XJ3	180
3P08	172	9P08	174	200 88 H	185	30032	186		
3P09	172	9P09	174	200 96 H	185	30043	186		
3P11	172	9P10	174	200 104 H	185	30044	186		
3P12	173	9P11	174	200 128 H	185	30151	186		
3P15	173	9P12	174	200 152 H	185	30215	186		
3P16	173	9P13	174	200 188 H	185	31512	186		
3P17	173	31P0	170	200 212 H	185	31515	186		
4C06	175	31P8	172	234CDS	175	31575	186		
4C07	175	31POST	170	275	176, 177	64006H	184		
4MA	181	33H040 CLAMP	180	275P	176, 177	64008H	184		
4P01	170	33H250 CLAMP	180	344CDS	175	64010H	184		
4P1X	173	33S248 CLAMP	180, 182	351	175	64012H	184		
4P02	170	41P0	170	375	176, 177	64016H	184		
4P03	170	41P8	172	375P	176, 177	64020H	184		
4P03ST	171	41POST	170	375PR	176, 177	64024H	184		
4P04	171	44U-405	181	413P	172	64028H	184		
4P05	171	51-44	179	417P	170	64032H	184		
4P05R	171	51-66	179	451	175	64036H	184		
4P06	172	56-22	179	475	176, 177	64040H	184		
4P07	171	56-32	179	475P	176, 177	64044H	184		
4P08	172	56-33	179	475PR	177	64048H	184		
4P09	172	56-42	179	532	173	64052H	184		
4P11	172	56-43	179	533	173	64056H	184		
4PVAF	169, 173	56-44	179	575	176	64064H	184		
4T/C	182	56-64	179	575P	176	64072H	184		
4T/WOC	182	56-66	179	613P	172	64080H	184		
4Y/C	182	56-86	179	650	174	64088H	184		
4Y/WOC	182	56-88	179	651	175	64096H	184		
06-44	178	56-125	179	675	176, 177	64104H	184		
06-64	178	56-150	179	675P	176, 177	81015	186		
06-66	178	56-150/125	179	822-040-16	177	81020	186		
06-88	178	56-1010	179	822-080-16	177	81030	186		
6C05	175	56-1212	179	880-136	177	81040	186		
6C06	175	56-2150	179	880-202	177	81050	186		
6MA	181	56-E43	179	880-234	177	81060	186		
6P01	170	56-E64	179	880-243	177	81080	186		
6P02	170	57-125	180	880-253	177	81100	186		
6P03	170	57-150/125	180	880-259	177	99080	186		
6P03ST	171	61P0	170	880-271	177	99125	186		
6P04	171	61P8	172	880-364	177	1530202	177		
6P05	171	64P01	170	1219	177	1530204	177		
6P06	172	64P08	172	1220	177	1530303	177		

# You Click, You Order. No Waiting.

Getting connected is easy... set up your account online, or call customer service. 800-7261994. Se Habla Español.

## ndspro.net

The 24 hour online dealer tool that helps you manage your NDS Business

Pricing Query

Instant Order Entry, No Wait

Check Discount Schedules

Check Order Status

Invoice Printing

Inventory Query

Manage Your Account

News Updates

Links to ndspro.com and Literature Direct



**NEW! Shopping Cart**  
Easy to Use & Convenient

## TERMS AND CONDITIONS OF SALE

---

**Terms:** Standard terms are NET 30 days. All invoices are to be paid in US Currency. Title and risk of loss pass to buyer upon shipment.

**Freight Allowance:** Freight prepaid on orders of \$2000.00 NET or more, with the exception of shipments to HI, Canada, AK, and PR Prepaid freight levels are based on shipments to one location only. It is the responsibility of the customer to determine if his purchase order meets the minimum freight allowance required. NDS reserves the right to select the carrier and point of shipment.

Canada, Hawaii, Puerto Rico & Alaska orders that include EZflow must be a minimum of \$4000 for prepaid freight Terms.

**Canada, Puerto Rico & Alaska:** Freight prepaid on orders of \$2500.00 (US\$) NET or more.

**Hawaii Orders:** Freight prepaid on orders of \$3500 NET or more.

**Errors & Claims:** All claims for shortage in shipment or damaged material must be noted on the “Bill of Lading” and a written request for credit submitted to NDS within 15 days of shipment. NDS responsibility ceases upon delivery to the carrier.

**Returned Goods:** Returned goods will be accepted only after written approval and shipping instructions are received from NDS. A return goods authorization number is required and must be on all cartons, documents, and correspondence. All returns are subject to a 25% restocking charge, freight cost of returned goods (plus “out freight if applicable”). A higher restocking charge may be assessed against any return requiring extraordinary handling costs.

**Minimum Order:** \$100.00 minimum order net billing.

**Broken Box Charge:** A 25% broken box charge will be added for other than full box quantities. 21DI Drip Components, 25DS Dura Slope Channel and 25FC Filcoten Channel are excluded from this policy.

**Limited One Year Warranty:** The liabilities of NDS are limited solely and exclusively to replacement as set forth in our standard “Statement of Warranty”, alone and do not include any liability for incidental, consequential or other damage of any kind whatsoever, whether any claim is based upon theories of contract, warranty, negligence or tort and without any limitations and do not include shipping charges, labor, installation or any other losses or expenses incurred in operation of any replacement specialty item or fitting. NDS drainage products are designed to be used for exterior surface drainage only.

All NDS products are guaranteed against defects resulting from faulty workmanship or materials. Claims for labor costs and other expenses required to replace defective products or repair of any damage resulting from the use thereof will not be allowed by NDS. Our liability is limited to replacement of products acknowledged by NDS to be defective.

**Exclusive Warranties and Remedies:** The foregoing remedies are exclusive and are given and accepted in lieu of (i) any and all other warranties, expressed or implied, including without limitation the implied warranties of merchantability and fitness for particular purpose; and (ii) any obligation, liability, right, claim or remedy in contract or tort, whether or not arising from NDS, Inc.’s negligence, actual or imputed. The remedies of customer shall be limited to those provided herein to the exclusion of any and all other remedies including, without limitation, incidental or consequential damages. No agreement varying or extending the foregoing warranties or these limitations will be binding on NDS, Inc., unless such is signed in writing by an authorized officer of NDS, Inc.

The liability of NDS, Inc., hereunder shall be limited to restoring to good working order, provided that NDS, Inc., is not required to restore the product to good working order when such failure is due to causes beyond NDS, Inc.’s control, including but not limited to, acts of God, acts of civil or military authority, priorities, strikes, floods, epidemics, war, riots, and other causes that are beyond the manufacturers control.

These provisions are complete and exclusive statements of all terms and conditions between NDS, Inc., and the consumer. These provisions may not be varied, supplemented, qualified or interpreted by any prior course of dealings, written or oral or by trade usage. No NDS, Inc. agent, officer or employee has authority to make any representation, promise or warranty concerning these provisions.

**FOR TECHNICAL INFORMATION, CONTACT: Technical Services, (888) 825-4716, [TechService@ndspro.com](mailto:TechService@ndspro.com)**

Visit [ndspro.com](http://ndspro.com) for more information.

---

Our products are engineered and produced for performance, durability, ease of installation and the efficient use of resources.



Your knowledgeable and trusted partner for the best in water management solutions



Residential Stormwater Management | Commercial Stormwater Management | Professional Irrigation | Flow Management

Visit [ndspro.com](http://ndspro.com) for:



Videos



Tools/  
Calculators



Downloads



Case  
Studies



Design  
Worx



Request  
a Quote

**ndspro.com**

NDS Customer Service  
851 N. Harvard Ave., Lindsay, CA 93247  
Phone: 800.726.1994 · 559.562.9888  
Fax: 800.726.1998 · 559.562.4488

**Se Habla Español**

Download our  
**Mobile App - Search  
for NDS Drainage**



A Proud Member of



**California Prop 65 Warning** | To meet the requirements of California Proposition 65, it is our responsibility to inform you of the following: Warning Some products sold contain chemicals known to the state of California to cause cancer, birth defects, or other reproductive harm. For more information, please go to [www.P65Warnings.ca.gov](http://www.P65Warnings.ca.gov)