

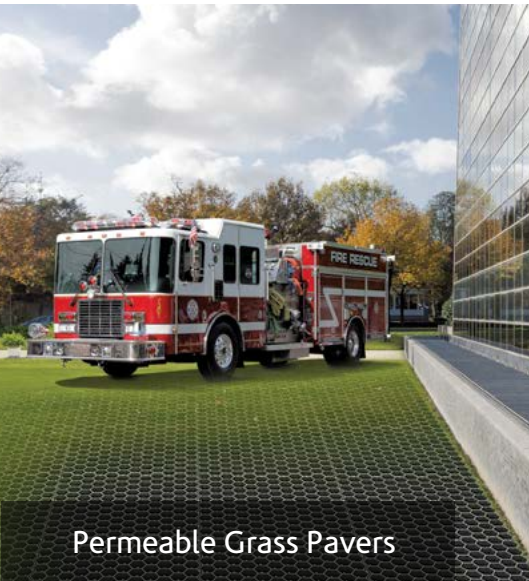

NDS[®]
We put water in its place

**Commercial
Stormwater**

Commercial Product Solutions



Permeable Grass Pavers

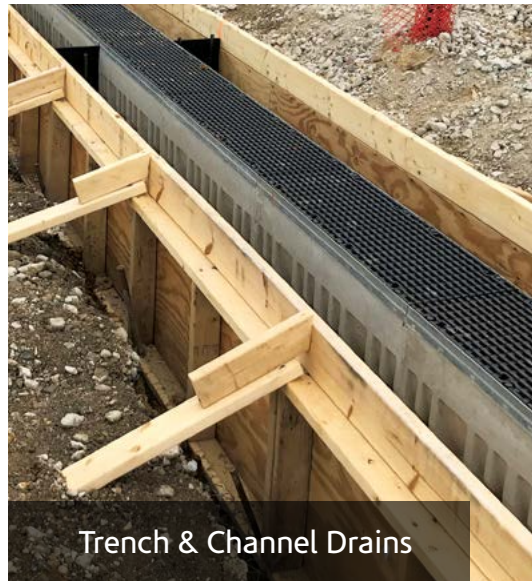

Trench & Channel Drains

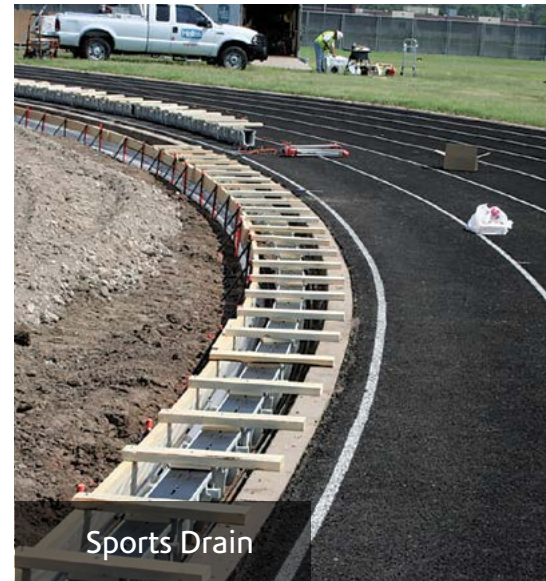

Sports Drain



Permeable Gravel Pavers

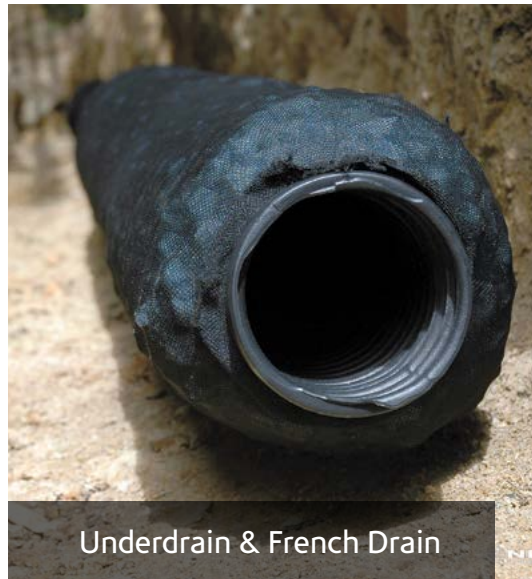

Underdrain & French Drain



StormChambers

Your knowledgeable and trusted partner
for the best in water management solutions



Since 1972, NDS has been producing plastic drainage and landscape products. From the beginning, our commitment to leading the industry has been unwavering, leading to remarkable innovations and state-of-the-art products that fit every environment, every schedule, every need.

1970's

Introduced the first plastic catch basin

- Plastic grates
- Channel drains

1980's

Expanded drainage product offering along with national sales & distribution

- New basin grates
- Additional channel drains

1990's

Focused on growth including:

- 18" & 24" Basins
- Pro Channel
- Metal grates

2000's

Invested in new product innovations:

- Dura Slope™ Pre-sloped Trench Drain
- Permeable Paver Systems

2010>PRESENT

Expanded product lines & partnerships:

- FILCOTEN Fiber-reinforced Trench Drains
- Dura Flo™ HD
- Control Zone Kits
- StormChambers™

Table of Contents

NDS® has the most comprehensive line of Water Management Products engineered to offer maximum performance for commercial and residential uses.

4 Catch Basins and Pop-up Emitters

6 Dura Slope™

7 EZ-Track™

8 FILCOTEN® by NDS®

10 NDS® StormChamber®

12 EZflow® Gravel-Free French Drain

14 Permeable Pavers

16 Professional Irrigation

16 Valve & Meter Boxes

17 Root Barriers

18 NDS® DesignWorx™

20 NDSpro.com

Stormwater Solutions for a Variety of Applications

NDS provides a diverse range of stormwater management solutions to capture, convey and retain stormwater.

Commercial Spaces

Scalable and flexible solutions for office buildings, banks, hotels, grocery stores and more.

- Stormwater detention and infiltration
- Reinforced turf and gravel with delineators
- Biofiltration and bioretention
- Parking and service area runoff



Parks and Recreation Areas

Scalable and aesthetic solutions to help you safely maintain golf courses, sports fields, patio and pool decks and other outdoor recreational environments.

- Mitigate stormwater runoff
- Eliminate standing water
- Reinforced turf and gravel delineators



Government and Public Spaces

Solutions to maintain safety and regulatory compliance in numerous public and government applications such as schools, government buildings and parks

- Parking and service areas
- Biofiltration and bioretention
- Large roof and courtyard runoff



Road and Highway

Load-rated DOT-compliant stormwater management solutions that can withstand the weight of heavy machinery, enabling you to protect roadways and pedestrian areas from unsafe standing water and excess runoff.

- Bioswale
- Roadway runoff
- Emergency access
- Streets and sidewalks



Sample Projects



FILCOTEN
Roadway (US Gov. in VA)



StormChamber
Detention

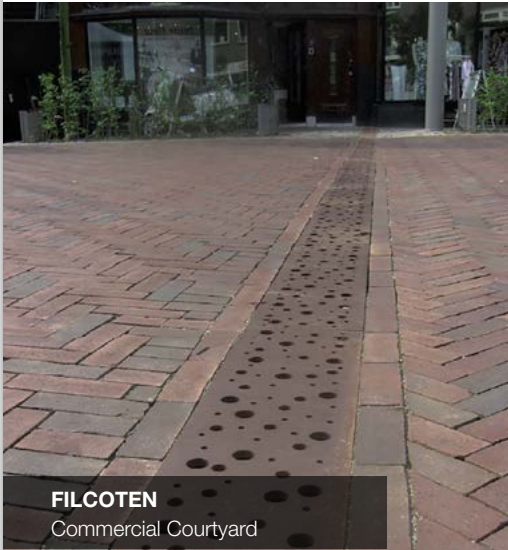

FILCOTEN
Commercial Courtyard

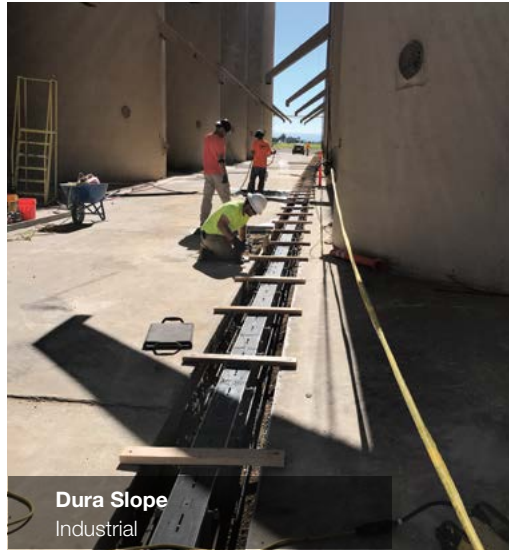

Dura Slope
Industrial

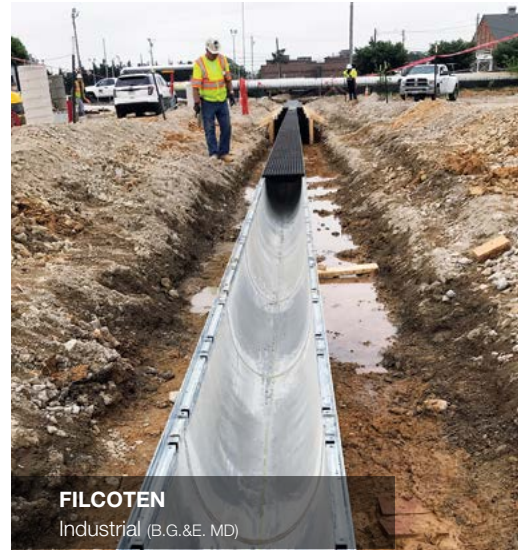

FILCOTEN
Industrial (B.G.&E. MD)



Dura Slope
Track

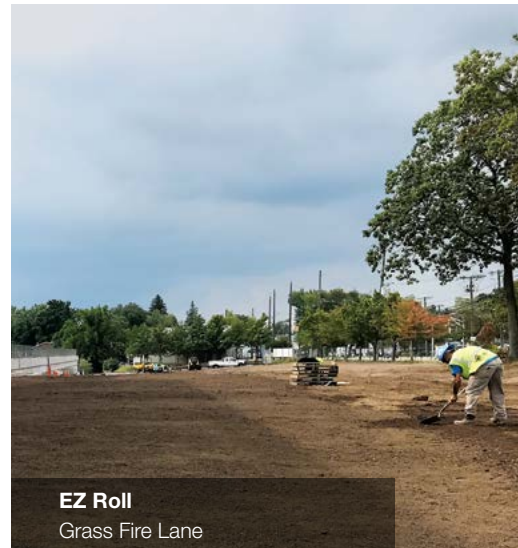

EZ Roll
Grass Fire Lane

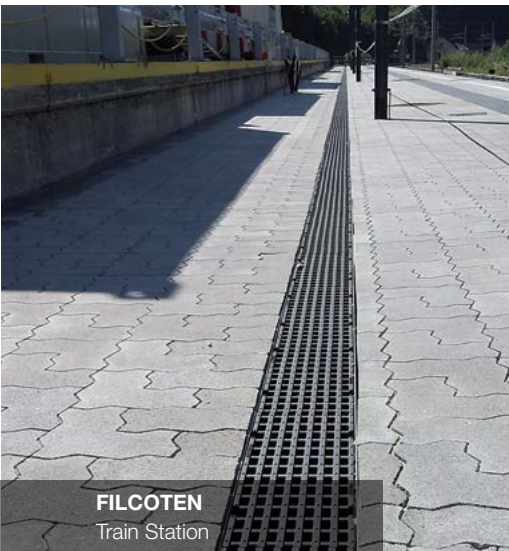

FILCOTEN
Train Station



FILCOTEN
Drainage (Public Road in NJ)

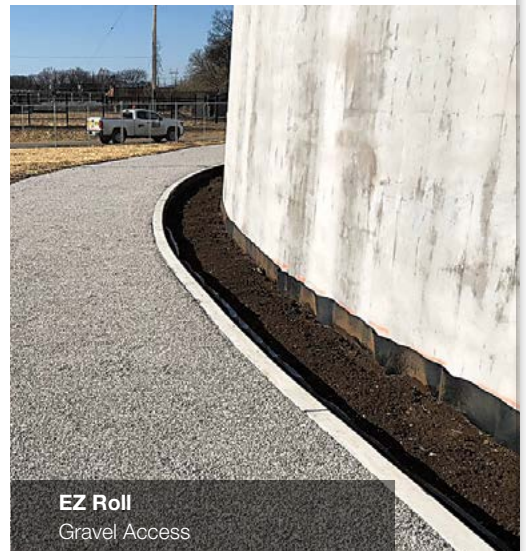

EZ Roll
Gravel Access

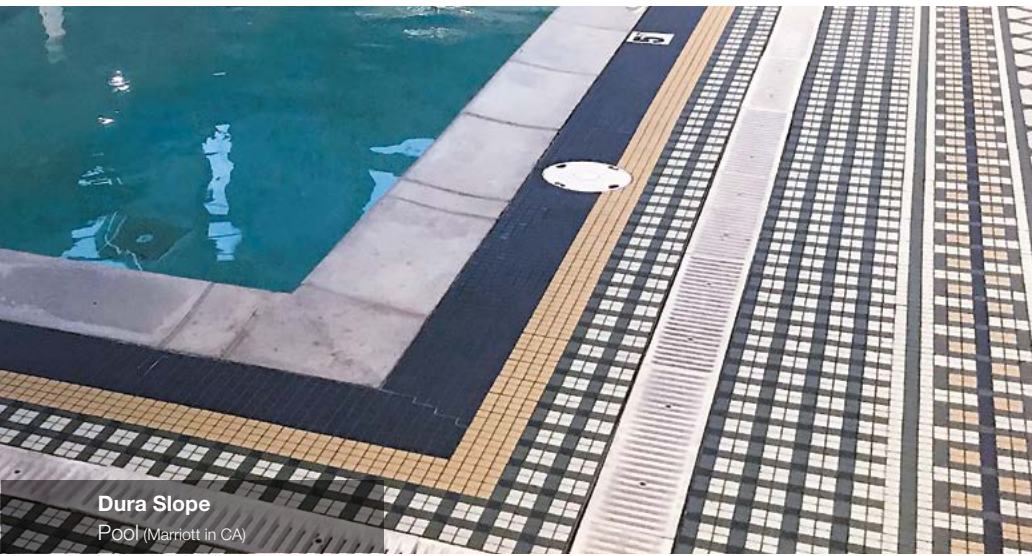

Dura Slope
Pool (Marriott in CA)

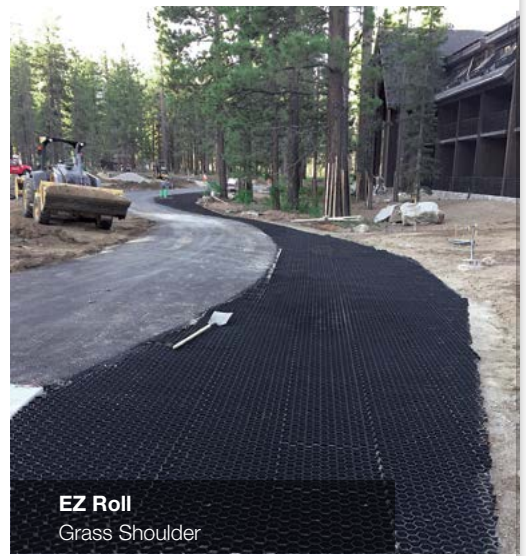

EZ Roll
Grass Shoulder



EZ Roll Grass
Fire Lane (LG Corporation in NJ)



FILCOTEN
Parking Garage



EZ Roll Gravel
Parking (Frontier Town/OGS NY)

Catch Basins & Grates

NDS offers a complete line of catch basins and grates for residential and commercial stormwater management solutions. NDS catch basins have sump areas that collect debris and prevent clogging of the pipeline, and grates are available in a variety of patterns and colors to blend in with surrounding surfaces. Depending on the size of the round, square, or atrium grates, they may fit directly into a riser of pipe, sewer and drain fitting, or our catch basins.

6" Round
Spee-D Basin

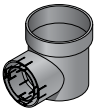

9" Square
Catch Basin



12" Square
Catch Basin

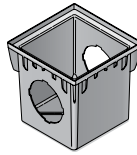

18" Square
Catch Basin

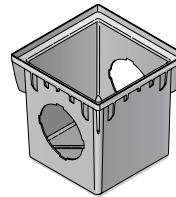

24" Square
Catch Basin

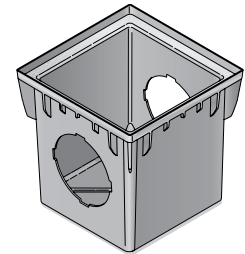

Basin Filters

Adding a filter is a simple solution to keep water flowing through a drainage system, and a cost-effective alternative to expensive repair or replacement.

Available for 9" and 12" catch basins.



Basin and Pipe Grates

Available in plastic, iron, steel, brass & chrome, from sizes 3" round to 24" square, in standard slotted, flat, atrium style and even decorative patterns.

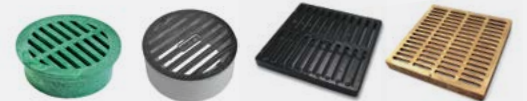

Low Profile Adapters

Low-profile adapters offer increased open-surface area and flow capacity compared to a smaller grate matching the pipe diameter, and are ideal in areas where there isn't enough depth for a full catch basin.

Available in square sizes 9", 12" and 18".



Pop-Up Emitters

An easy and efficient solution that allows water to be diverted and released to water-safe areas away from structures, erosion-prone landscapes and poor drainage areas.



Flexible and Scalable Solutions

NDS offers many standard details or can provide custom versions. For the best installation make sure the flow, grate, pipe size and invert height all match. Call us for assistance: 888-825-4716 or email TechService@ndspro.com

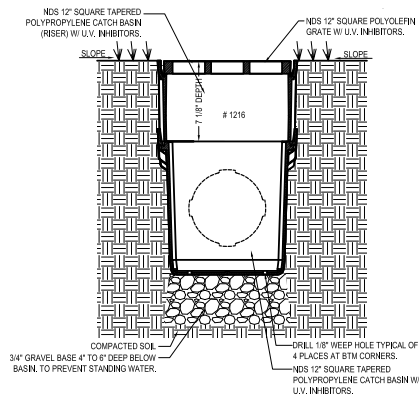

Example: 12" Catch Basin with Single Riser

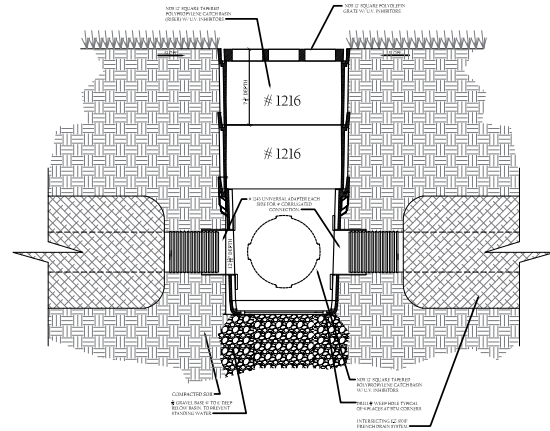

Example: 12" Catch Basin with Two Risers

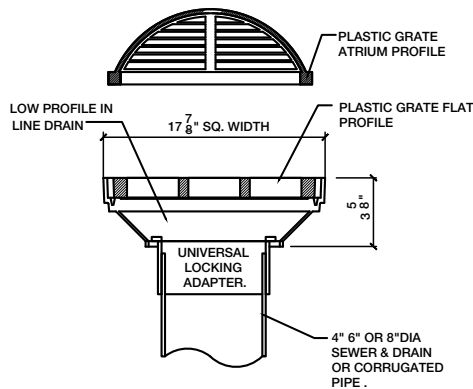

Example: Adapter with Dome Grate

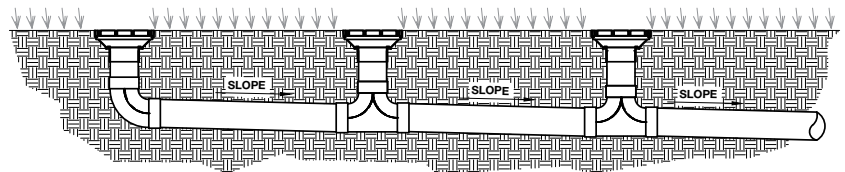

LOW PROFILE ADAPTER - LANDSCAPE APPLICATION

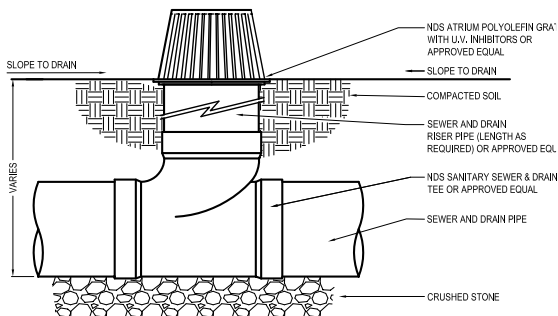

Example: Fitting and Dome Grate

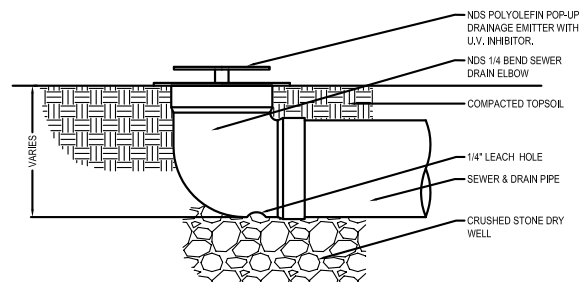

Example: Fitting and Pop-up Emitter

Dura Slope™ Trench Drain

Pre-Sloped (patented)

NDS Dura Slope™ is a high-quality, dependable, best-in-class trench drain system ideal for a variety of drainage solutions, including driveways, parking areas, warehouses, loading docks, pools, wash down areas and other areas for the interception and collection of surface runoff. Dura Slope™ pre-sloped and neutral trench drain system provides a solution for residential, commercial, industrial and municipal drainage needs.

6" width, sloped and neutral. Low-profile slot top grate available.

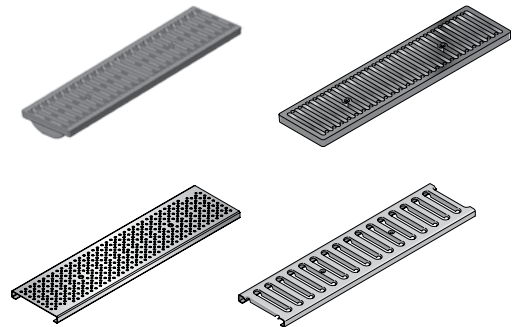
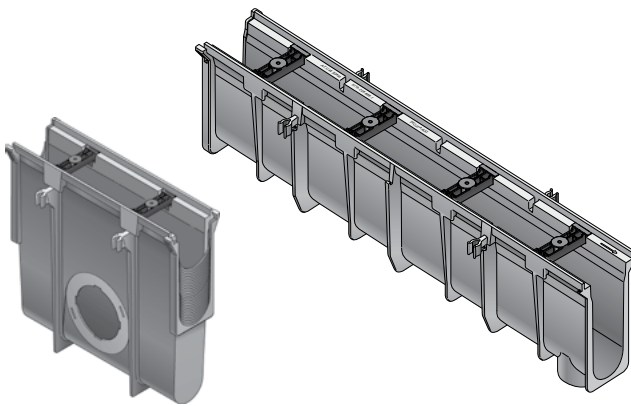

Linear Fall with Neutrals

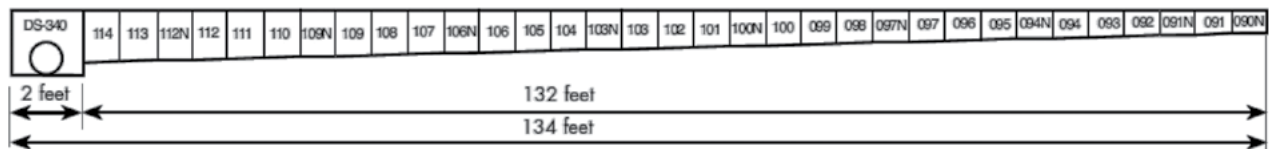

9 Neutral Channels 4" up to 12.5" Depths 25 Pre-sloped Channels 4" up to 12.5" Depths H20 Loading

- Pools
- Driveways
- Stairs
- Basements
- Gas Stations
- Loading Docks

Grate Options:

- HDPE colors: Red, Black, Green, Brown, Light Gray
- Galvanized, Stainless, Ductile Iron
- Load A-D
- ADA Heel-Proof Options

EZ-Track™

Sports Drain System

Designed specifically for draining 400-meter running tracks, Dura Slope™ Radius Couplings allow 3° of deflection between trench drain sections, making an adjustable radius easily achievable for standard tracks and other curving applications.



- 1 Faster install, snaps together
- 2 High efficiency with 25% less labor
- 3 No breakage with HDPE
- 4 Higher capacity
- 5 Light weight, easy to carry
- 6 No cutting plywood, comes with dummy
- 7 Flex couplings give smooth radius “D” areas
- 8 Simple to cut with wood saw
- 9 Freight is included
- 10 Made in USA

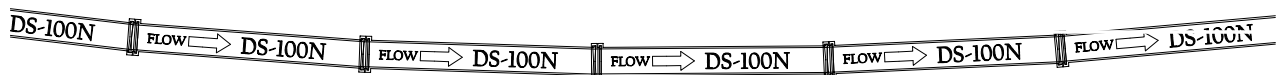
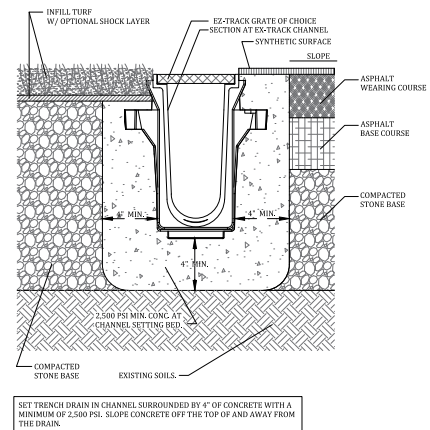
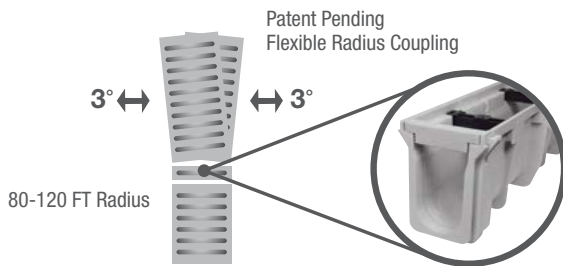

Radius Couplings

FILCOTEN[®] by NDS[®]

HPC Concrete Trench Drain

FILCOTEN[®] by NDS[®] combines smart engineering and smart materials to provide a superior trench drain suitable for handling a high-load capacity.

4", 8" & 12" widths, sloped and neutral.



- 1 No polymers (Green Technology)
- 2 Fiber reinforced concrete
- 3 No releasing agents used in de-molding
- 4 Integral rail system
- 5 4-point self-locking system
- 6 Reduced friction
- 7 Pegs to prevent grate shifting
- 8 Flush wall design
- 9 Exceeds H 20
- 10 DIN load rated A to F, 134,000 lbs.

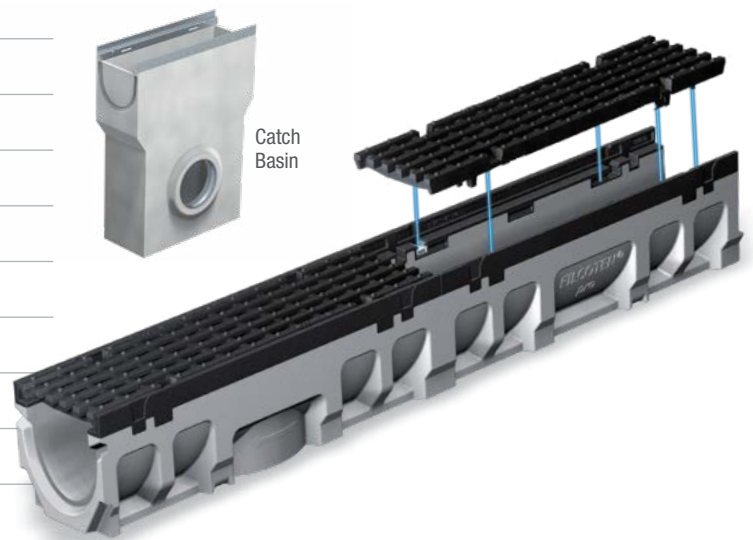

FILCOTEN comes in 4", 8" and 12" Widths, Sloped & Neutral



4" FILCOTEN Tec V 100



8" FILCOTEN PRO V 200



12" FILCOTEN PRO V 300

FILCOTEN Grate Materials & Styles



Slotted
Galvanized Steel



Perforated
Galvanized Steel

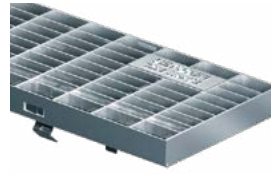

Mesh
Galvanized Steel



Slot Top Galvanized
or Stainless Steel



Slotted
Ductile Iron



Longitudinal Bar
Ductile Iron



Honeycomb
Plastic



Kiaro



Via



Ville



Made to Order

Additional Styles and finishes
available upon request.

Heavy-Duty Solutions for Every Application

We can help size your drain and provide a layout.

Tell us your application; Load capacity; invert height; required flow...

Contact us for assistance: **800-726-1994** | DesignWorx@ndspro.com

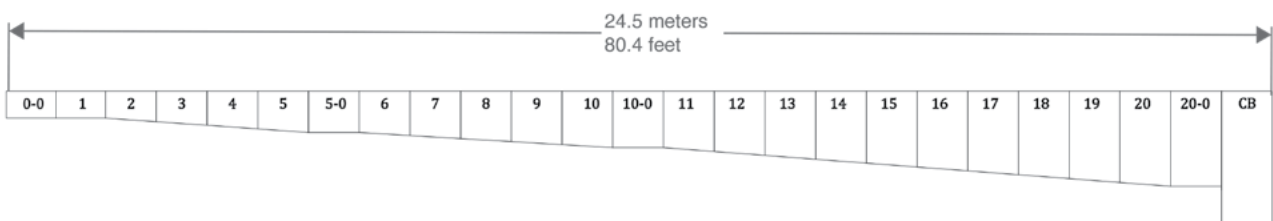
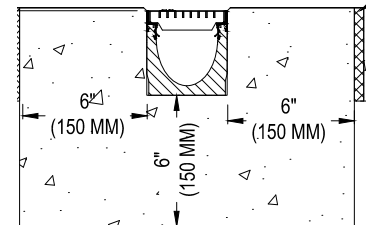

NDS® StormChamber®

Underground Stormwater Management



Offering superior strength, fast, easy installation and simple maintenance, NDS StormChamber™ is the most cost-effective chamber solution.



Tools & Support

Our team of experts is on hand to offer design assistance. Contact us with your questions or for design support & tools.

- Call: 800-726-1994
- Email: DesignWorx@ndspro.com



Fast Installation

Save time, money, and avoid extra excavation. Ideal for roadways, parking lots and fields.

- Built in end walls
- No header pipe manifold system required
- Flexible design
- Lowest installed cost



Simple Maintenance

Less time, less money and more forgiving.

- Differentiated and centralized sediment control through our propriety SedimenTrap™
- SedimenTrap™ gathers sediments and other pollutants in one place for quick, easy and inexpensive removal by vacuum truck

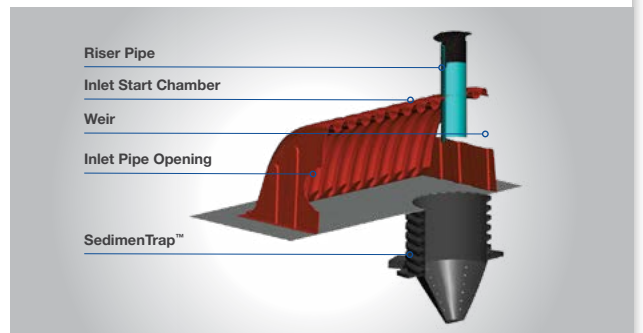

Structural Components

Meets H-20 Standards

- Up to 16' cover when deep installs are required for the 34" and up to 12' for the 44"
- The 18" can handle a maximum of 16' of cover, but is better suited for shallow installation needs
- Withstands the most extreme environments
- Material bends instead of breaks giving it a brittleness temperature of -107°F vs. industry average of -2°F
- 100 year life expectancy, longest on the market



Stack

Allows for deeper installation and a smaller footprint

- 34" Chambers: Capable of 3-layer stacking
- 44" Chambers: Contact NDS DesignWorx for any projects that may need stacking
- We offer expert site-specific design guidance based on 20 years of successful completion of projects



NDS® StormChamber®

Plan View

(Configuration Example)

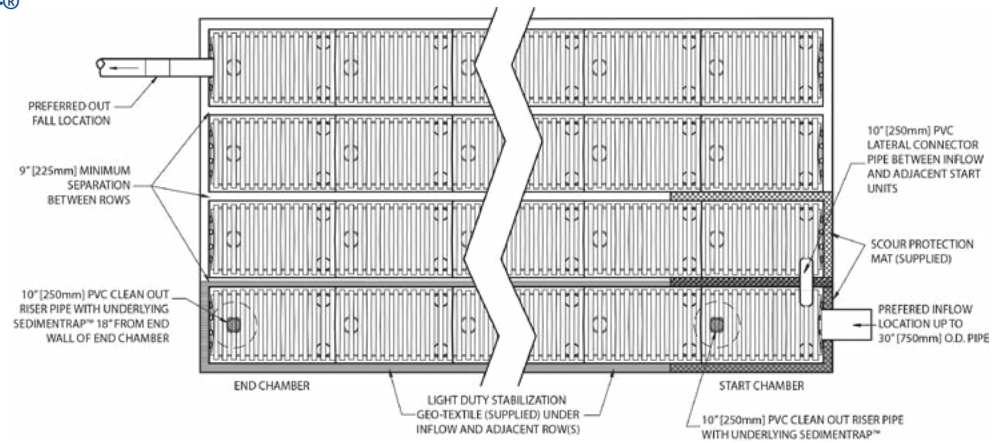

NDS® StormChamber®

Elevated View

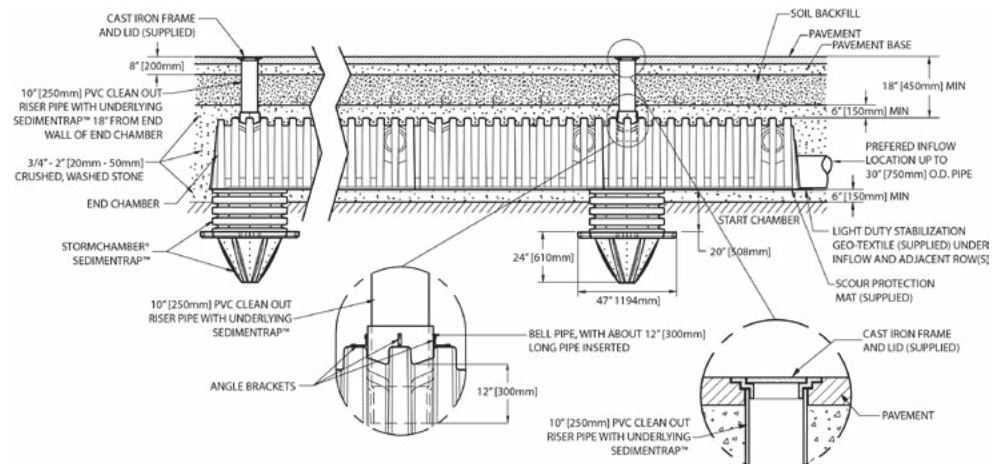

EZ-Flow

Engineered French Drain Solution

EZflow is an engineered French drain system incorporating a polystyrene aggregate that provides enhanced performance, strength, filtration and longevity. EZflow is faster and easier to install than gravel and pipe, saving time and money on your project.



Light Weight

Gravel-Free French Drain

- All-in-one system with up to 50% labor savings
- 30% better flow than gravel French drains
- More accessible than stone and pipe
- Suitable for a wide range of soil types
- Crush resistant with proper installation
- Built to last with a 100-year product lifespan
- Compliant with applicable drainage codes and standards
- ICC approved

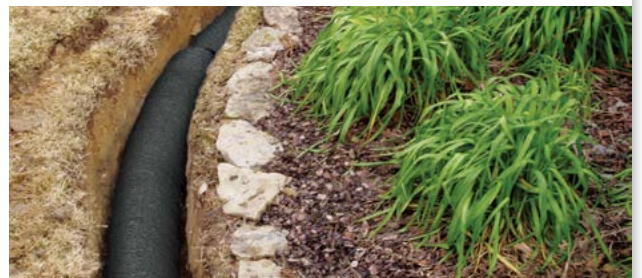

Landscape Drains



Behind Wall or Foundation

Performance Innovation

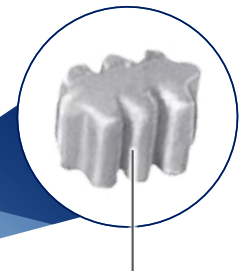
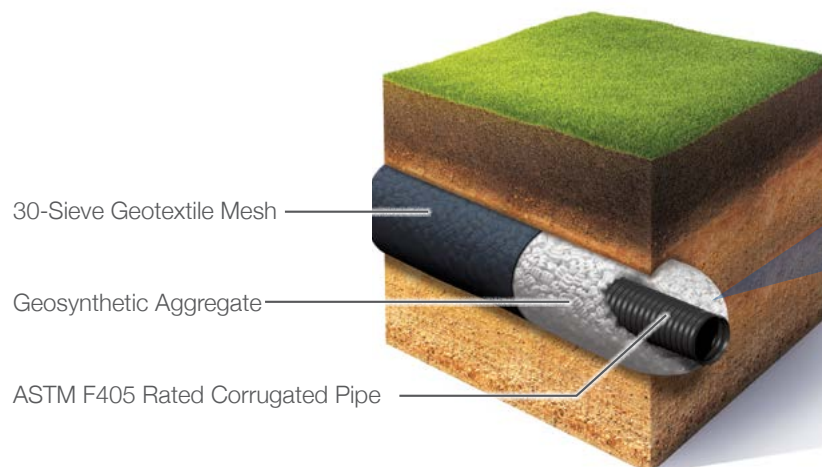

Engineered flow channels increase void space, creating improved water flow and greater storage.

Lightweight expanded polystyrene aggregate offers structural integrity and resists compaction.

Infiltration Trench Solution

- Narrow for tight spaces
- Cleaner than stone.
- 45% void space, better than stone.
- Gang together for additional capacity.

Product Options:
 Pop-Up Emitters
 Basins with Grates

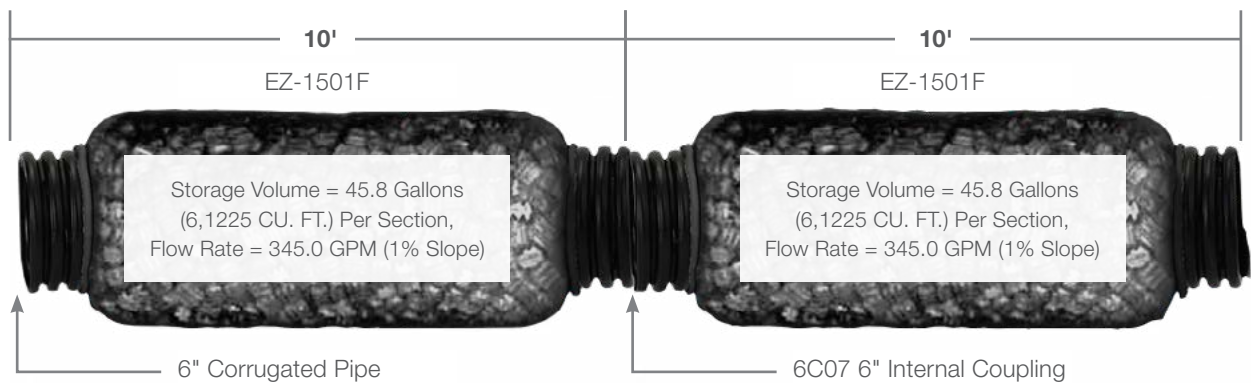
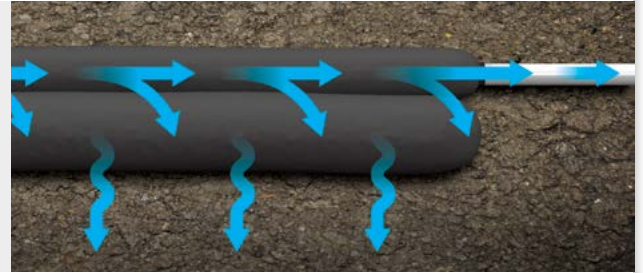

Drainage Bundles

EZ-0701F

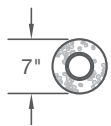

3" PIPE (CENTERED)

EZ-1001F

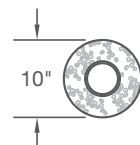

4" PIPE (CENTERED)

EZ-1501FB

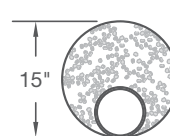

6" PIPE (BOTTOM)

EZ-1501

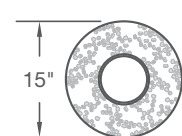

6" PIPE (CENTERED)

EZ-0701A

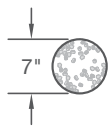

NO PIPE

EZ-1001A

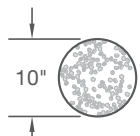

NO PIPE

EZ-1501A

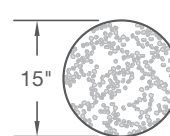

NO PIPE

Permeable Paver Products

For Grass & Gravel

Permeable Pavers provide an alternative solution to traditional paving methods. Creating a strong grass or gravel surface that can support heavy vehicles, they maintain permeable surface areas, eliminating or reducing stormwater runoff.



Benefits

Greatest Compressive Strength*. Offering a high load-bearing capacity, NDS Permeable Pavers feature hexagonal cells that connect together to form a flexible grid system capable of handling significant structural loads.

Easy Installation. EZ Roll™ products come in large rolls that are easily placed and clipped together. Tufftrack™ features an integrated easy to assemble clip, that greatly reduces installation time.

Reduced Maintenance. Less expensive to maintain over time than traditional hardscaping and reduces demands put on landscape drainage systems.

Environmentally Friendly. NDS Permeable Pavers contribute to LEED credits and are made of up to 100% recycled plastic.

Tufftrack™ Grassroad Paver Panels

86,563 psf.

Available in:
24" x 24" panels, 1.5" thick

- Cells filled with wet soil have a compressive strength of 400,000 psf
- Product ships in 24 in. squares for easy layout
- Unique tongue & groove clips are easier to install



Tongue & Groove clips
reduce installation time



EZ Roll™ Grass Paver Rolls

53,683 psf.

Available in:

3.96 ft. x 24 ft. rolls – 97 sq. feet total

3.96 ft. x 152 ft. rolls – 601.6 sq. feet total

- Cells filled with wet soil have a compressive strength of 400,000 psf
- Product ships in large rolls for easy rollout
- Easy to connect locking tabs on sides and ends



Easy to install
pre-assembled rolls

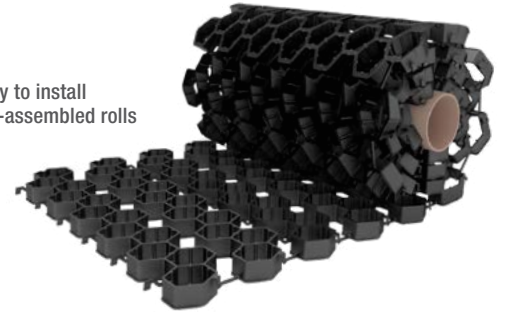

EZ Roll™ Gravel Paver Rolls

53,683 psf.

Available in:

3.87 ft. x 149 ft. rolls – 577 sq. feet total

Black GP4X150	Gray GP4X150G
Tan GP4X150T	Brick Red GP4X150R

- Cells filled with 3/8" Gravel have a compressive strength of 500,000 psf
- Product ships in large rolls for easy rollout
- Easy to connect locking tabs on sides and ends



Easy to install
pre-assembled rolls

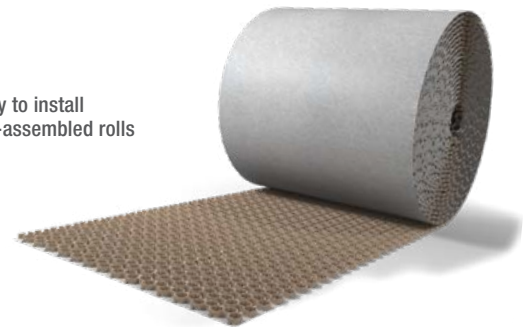

EZ Marker™ Parking Delineators

300 PSI class "C" compressive strength

Available in:

2.7" hexagonal shape

0.40" profile above paver grade

- Molded polypropylene, impact copolymer
- Easy clip-in installation
- Self-cleaning: Raised dome design prevents debris from sticking



Can only be used with
NDS EZ Roll™ pavers

Dura Flo™ Dripline & Accessories

Dura Flo™ JR

Non-pressure compensating 1/4" dripline tubing. Ideal for small plantings, gardens and flower pots.

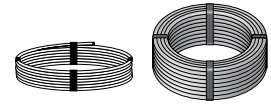

Dura Flo™ PC

16mm, 17mm & 18mm pressure-compensating dripline for densely planted landscape applications.

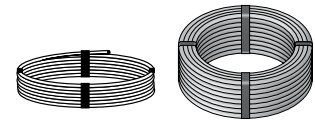

Dura Flo™ CV

17mm & 18mm pressure-compensating dripline with check valve for densely planted landscape applications.

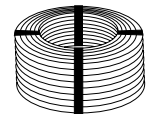

Dura Flo™ HD

Heavy-duty, pressure-compensating, thick-walled 3/4" dripline for high-traffic commercial landscape applications.

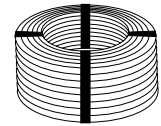

Control Zone Kits

1-inch, 30 PSI and 40 PSI control zone kits with or without flow control. 40 PSI kit available in combo kit with valve box.

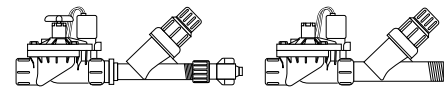

Valve & Meter Boxes

NDS Valve and Meter boxes are proudly manufactured in Lindsay, CA, and span a wide variety of sizes, from 6" round to 17" x 30" rectangular. Available with black, green, purple, gray, brown and sand covers with designations including irrigation control valve, water, sewer, electric, reclaimed water, cable TV, telephone and others. All NDS boxes and lids contain UV inhibitors for sustained durability and performance in direct sunlight.



Specification Series Valve Boxes

Pro Series & Pro Series Plus

Designed for commercial applications. Injection-molded of high-impact, high-density structural foam polyethylene.

Custom lid inserts available for large opportunities.

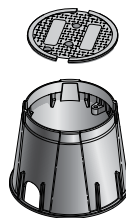

Round
10"

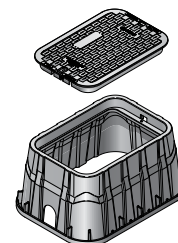

Rectangle

14" x 19" Standard
13" x 20" Jumbo
13" x 24"
17" x 30"

Root Barrier Panels

Root barrier products direct root growth from shrubs and trees downward, dramatically decreasing the roots' potential to clash with and penetrate nearby hardscapes, walls, or building foundations. They provide protection against the high cost of reparations due to cracks in foundations and buckled sidewalks and driveways.



Modular EP Series Root Barrier Panels

Made from injection molded High Impact Polypropylene (HIPP) with a unique factory installed joiner strip that eases installation. EP Series Panels include a "T" top edge to prevent root overgrowth and an Anchor Lock™ external flange at the base to lock panels in the ground. Suitable for all planting installations.



Quad Clip™

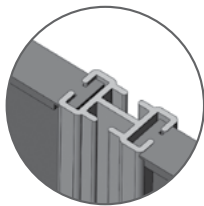

Joiner Strips

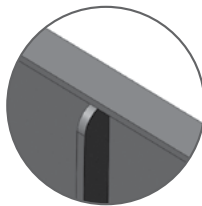

Reinforcing Ribs

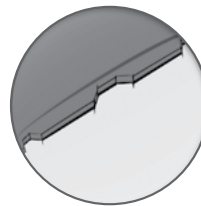

Anchor Lock™

Specifications

Each Barrier is a minimum of 0.090 inches thick and is made of up to 50% post consumer High Impact Polypropylene (HIPP) with U.V. inhibitors to ensure longevity. Barrier Panels have 1/2" raised vertical ribs running perpendicular to the panel and are 6" on center.



With NDS DesignWorx™ We Can Draft Your Plan.

NDS civil engineers and expert technicians are ready to partner with you to make your project successful. Our team will work with you to assess the feasibility of incorporating NDS products to align with best stormwater practices and save costs.

We will evaluate your plans & help in preparation of submittal drawings, including:

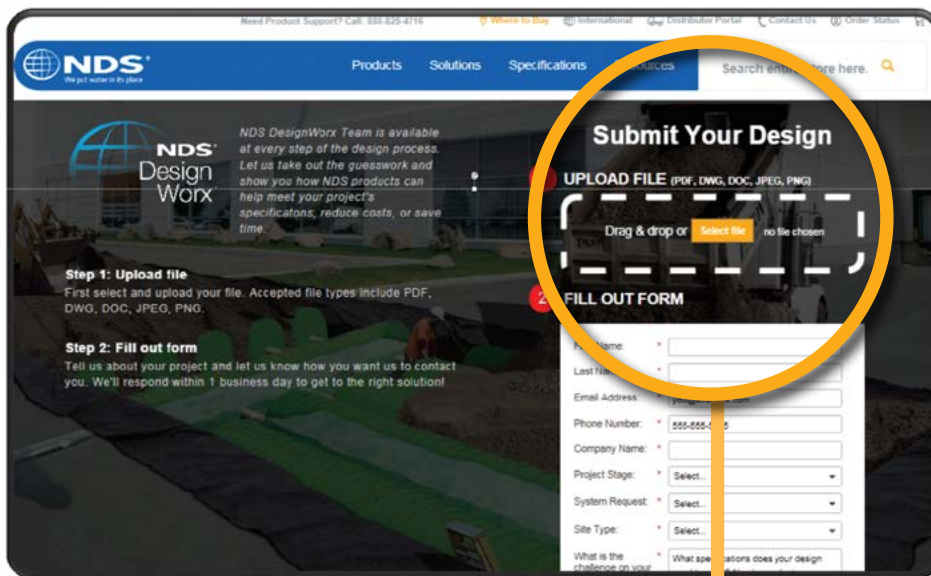

Just Upload CAD or PDF Thru Website:
NDSpro.com/submityourdesign

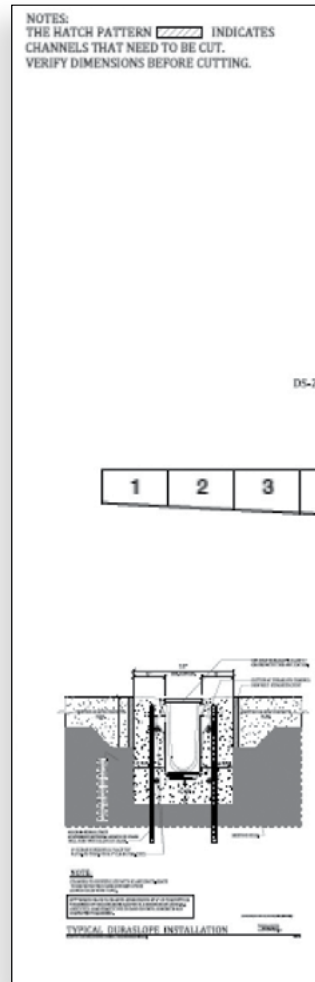

! Find Us on CAD Details:
CADDETAILS.COM

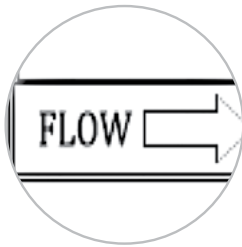

Direction of flow detail



Identify all parts



MATERIALS LIST		
PART NO.	QTY.	REC.
091	7	
12	7	

List of all materials

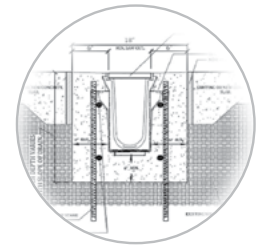
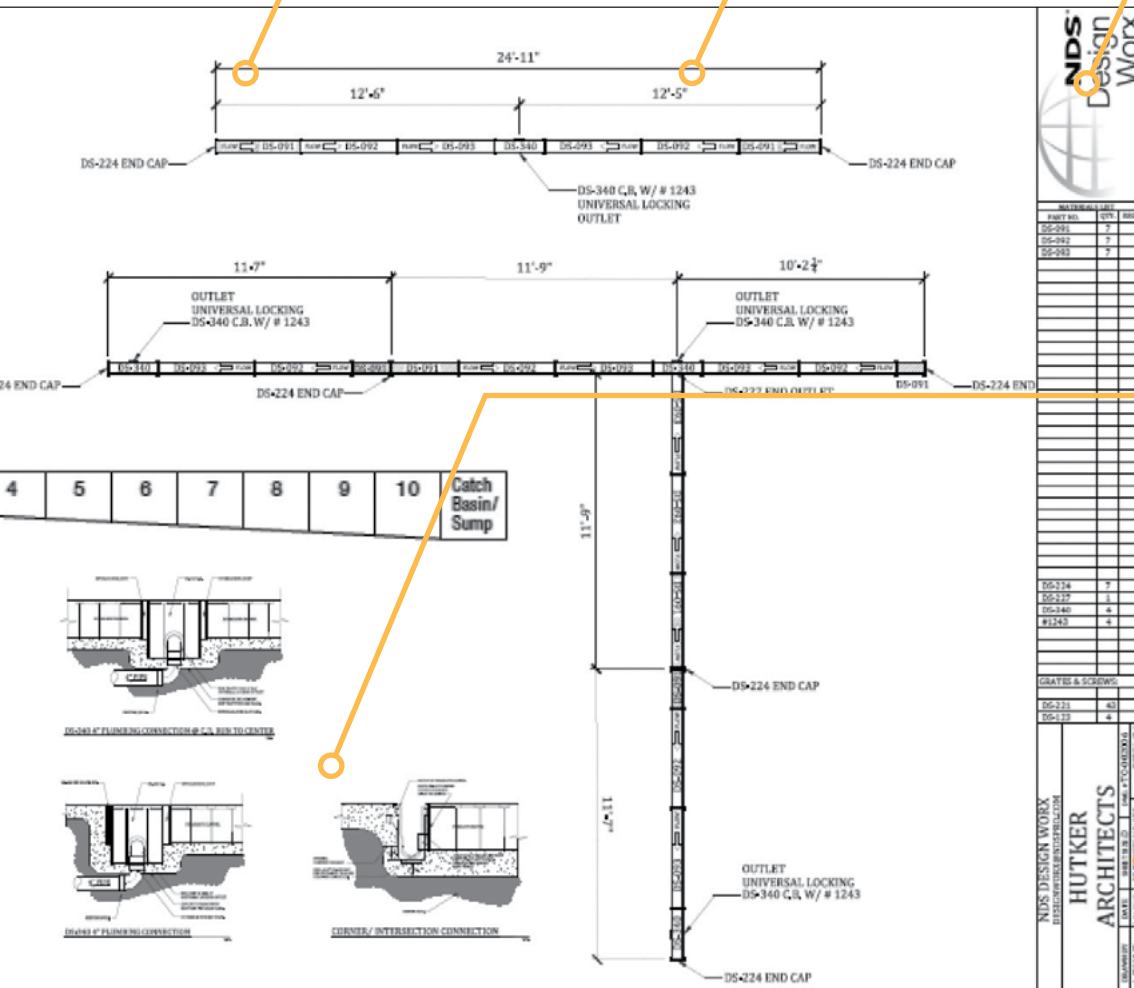

Installation details



Your company on title block

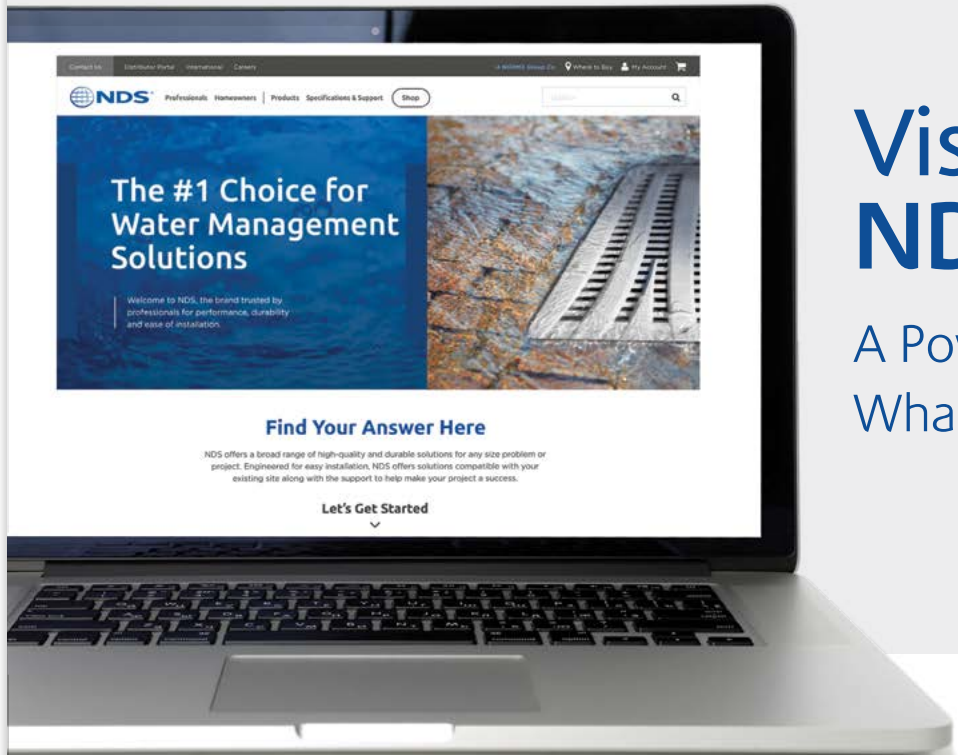

Visit NDSPRO.com

A Powerful Tool to Find What You Need Fast

Comprehensive Content

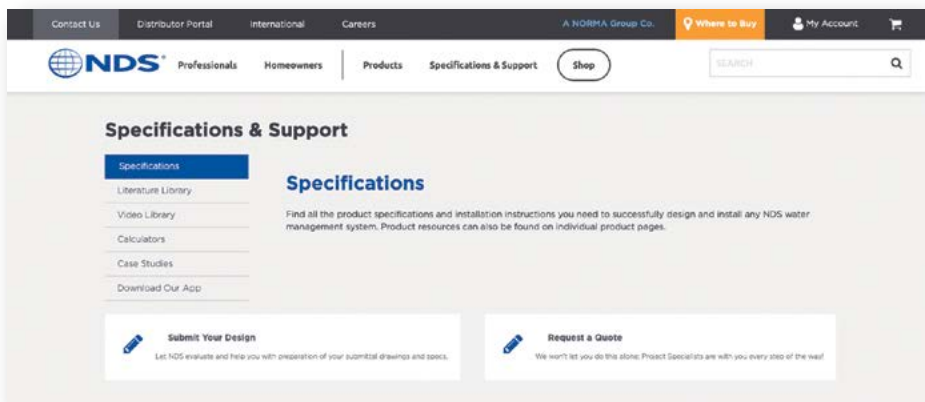

Search for specifications, technical documents and construction details.

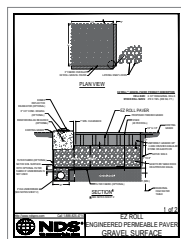

Left to Right:
Capacity Charts
Lab Testing
Written CSI DIV Specifications
Installation Details PDF/DWG

Product Literature

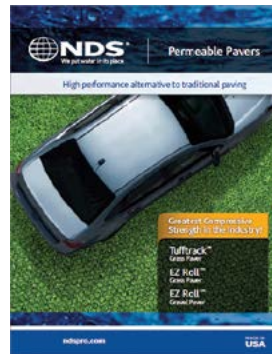

Left to Right:
Installation Manuals
Product Brochures
Case Studies

Video Library



Installation Videos

Tools & Calculators

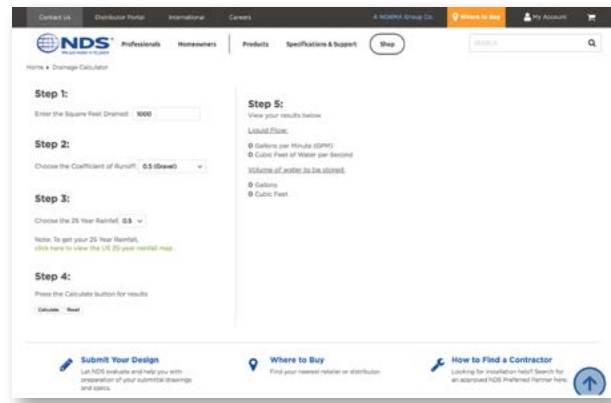

Mobile App

Get NDS on the Go!

Download our Mobile App to access our product catalog, online calculators and planning tools.

[Search for NDS Drainage](#)

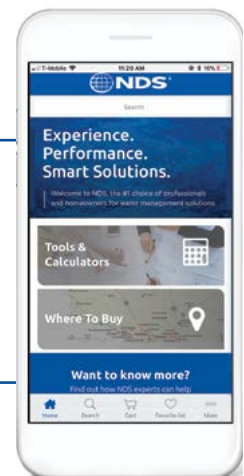

From NDS®

The Leader in Stormwater Management



Personal Support – Onsite

Lunch and Learn

NDS can provide a 1-hour seminar, during lunch, at your offices.

Content covered is relevant to today's stormwater LID challenges for; engineers, landscape architects, surveyors, estimators or contractors. In addition to lunch, we can provide certificate of attendance for 1 educational credit hour. Topics covered include solutions ranging from permeable grass and gravel paving systems to area drain/trench drain/drain slots.



Jobsite Visits

We have feet on the street and can provide on-site installation training, technical support and problem solving. Our goal is to facilitate the best possible project outcome for your client.



Our Brand Promise:

It comes down to three things – it's at the center of everything we do.

- 1 Knowledge and Expertise.** NDS is your knowledgeable and trusted partner for the best in water management solutions.
- 2 Product Innovation and Performance.** Our products are engineered and produced for performance, durability, ease of installation and the efficient use of resources.
- 3 Service and Support.** We provide the service and support to ensure that you are successful.

Visit ndspro.com today for:



Videos



Tools/
Calculators



Downloads



Case
Studies



Design
Worx



Request
a Quote

NDS Customer Service

851 N. Harvard Ave., Lindsay, CA 93247
Phone: 800.726.1994 · 559.562.9888
Fax: 800.726.1998 · 559.562.4488