



NDS®
We put water in its place

Your knowledgeable and trusted partner for the best in water management solutions



Residential Stormwater Management | Commercial Stormwater Management | Professional Irrigation | Flow Management

2024 | 2025

Product Catalog

ndspro.com

MADE IN
USA







CHANNEL & TRENCH DRAINS



CHANNEL AND TRENCH DRAINS

Channel & Trench Drain Product Line-up

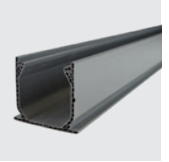
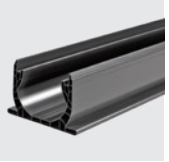
NDS Channel and Trench Drain Systems provide durable and proven solutions for sheet-flow drainage in applications ranging from light foot traffic to heavy vehicular traffic.

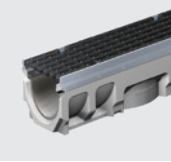
PROFILE SERIES						
Micro Channel™	Slim Channel	Mini Channel™	Spee-D® Channel	Pro Series Channel™	Dura Slope™	BG-FILCOTEN®
						
Pools, Spas, Patios	Patios, Pools, Spas, Walkways & Paver Landscapes	Pools, Patios, Tennis Courts	Pools, Pool Decks, Driveways	3", 5", 8" and 12", Patios, Driveways, Sports Fields	Driveways, Parking Lots, Courtyards	4", 8" and 12", Fiber-reinforced Concrete

CHANNEL & TRENCH DRAINS

Durable

Designed for maximum durability, drainage, and performance NDS Channel and Trench Drains are a proven alternative to traditional concrete drains. UV inhibitors in the plastic grate, channel and component parts prevent fading and cracking from the sun. All plastic grate and channel components are **chemically resistant, rustproof, and maintenance-free**.

Simple

NDS Plastic Channel and Trench Drains are light weight and easy to install. Grates are removable for easy clean out and replacement. Grates may be held in place with screws or hold-down clips. A complete line of accessories is available for each Channel and Trench Drain System. Our "Profile Series" of channel drains connect like PVC pipe. Our modular "Pro Series" injection-molded channel has mechanical interlocking joints. Our "Dura Slope" Trench Drain System is injection-molded, modular, has mechanical interlocking joints and a built-in slope. All NDS Channel and Trench Drain Systems easily connect to sewer and drain pipes and fittings or Sch. 40 pipes and fittings.

Versatile

To blend with surrounding surfaces, our plastic Channel Grates are available in six colors, some with decoartive options, as well as solid brass for the Mini Channel. Cast iron and rolled steel grates are available for the Dura Slope and Pro Series Channel. A ductile iron frame is also available. NDS Channel and Trench Drains also offer a choice of outletting locations; bottom, end and side options available.

Efficient

Channel and Trench Drains eliminate the need for grading a deck surface to a low area. Instead, the deck is gradually sloped in one direction or plane, and the channel drain acts as a perimeter drain at the edge of the slope to receive sheet-flow runoff. Channel and Trench Drain Systems provide more overall open surface area than conventional area grates.

Recommended Applications











- Driveways
- Warehouses
- Washdown Areas
- Loading Docks
- Tennis Courts
- Patios
- Nurseries & Greenhouses
- Plazas
- Parking Lots
- Swimming Pools & Spas
- Running Tracks
- Courtyards
- Sidewalks
- Sports Facilities
- Manufacturing Facilities
- Landings

See capacity recommendations for channel & trench drains, pages 79 & 87.

CHANNEL AND TRENCH DRAINS

Application Matrix – Choosing the Right Product

CHANNEL & TRENCH DRAINS

Top Applications		Micro Channel™	Slim Channel	Mini Channel™	Spee-D® Channel	3" Pro Series Channel™	5" Pro Series Channel™	8" Pro Series Channel™	12" Pro Series Channel™	Dura Slope™	BG-FILCOTEN®
	Pool Decks & Patios	●	●	●	●	●	●	●	●	●	●
	Sidewalks & Walkways	●	●	●	●	●	●	●	●	●	●
	Plazas & Courtyards		●	●	●	●	●	●	●	●	●
	Residential Driveways			●	●	●	●	●	●	●	●
	Sports Facilities						●	●	●	●	●
	Factory Floors						●	●	●	●	●
	Loading Docks						●	●	●	●	●
	Washdown Areas						●	●	●	●	●
	Parking Lots						●	●	●	●	●
	Warehouses (hard-tire forklifts)									●	●

PROFILE CHANNEL DRAINS

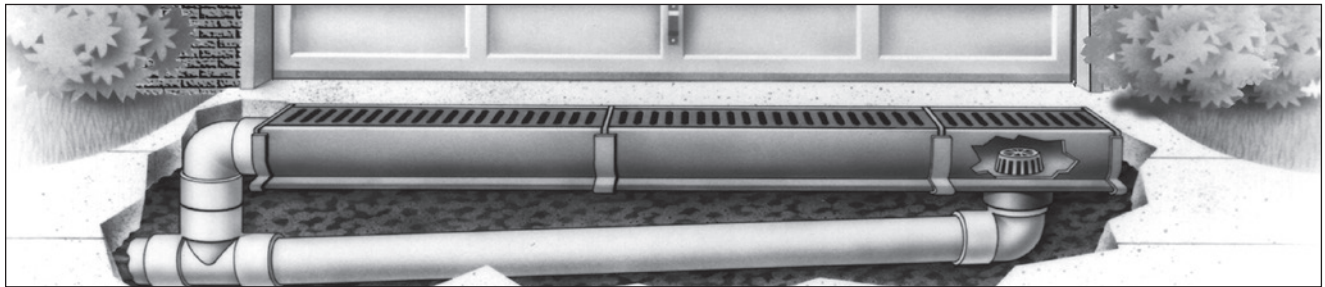

Details

Unique patented flying buttress design provides load-bearing support from both sides as well as underneath.

Available in three sizes: Spee-D® for driveways, large decks and commercial areas; Mini for landscapes, pools or decks; and Micro for residential pools and spas.

Unique flanges on the bottom of the channel provide an anchoring lip for straight installation and prevents floating.

Materials and Standards

- Only channels made of PVC can be cut to any length and solvent-welded like PVC pipe.
- rates available in six colors with decorative options – see individual products for details.
- Mini Channel Grate also available in solid brass.
- Channel system offers choice of bottom, end or side outlets.
- Concrete is not required under some channels for light vehicular applications. Standards vary per product.

Mini and Spee-D® Channel System Components

1. Channel
2. Grate
3. Coupling
4. End Cap or End Outlet
5. Channel Bottom Outlet
6. Sewer and Drain Fitting
7. Drain Pipe

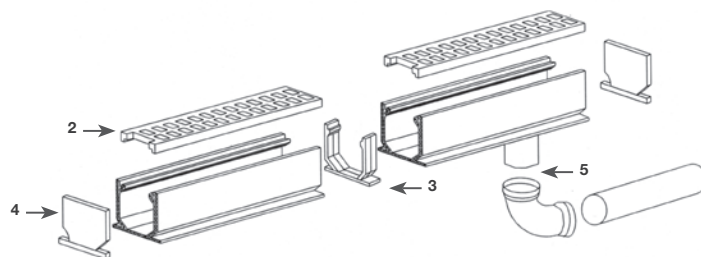

Slim Channel System Components

1. Robust extruded PVC channel available in 6-ft and 9-ft lengths
2. Anchor clips help secure the channel to a prepared base or suspend it with rebar
3. Attractive grate designs enhance any landscape and have high flow capacity for superior drainage
4. Couplers provide a secure channel-to-channel connection
5. End caps have a convenient KNOCKOUT for outletting to 1.5-in SCH 40 pipe
6. Convenient bottom outlets can be installed anywhere along the channel for 1.5-in SCH 40 pipe connections

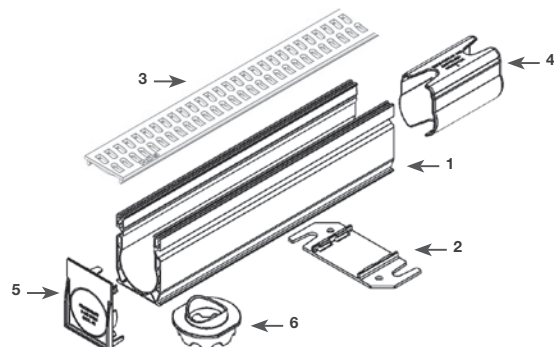

PROFILE CHANNEL DRAINS

Micro Channel™ Drains

Excellent performance at lowest possible cost. Designed for residential applications including swimming pools, spas and patios. Unique design features grate openings parallel to channel length and recessed grate for strength and effective runoff capture.

CHANNEL & TRENCH DRAINS

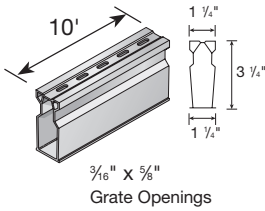

Part No.	Description	Color	Pkg. Qty.	Wt. Ea. (lbs.)	Product Class	Specifications	
8001	10' Long Micro Channel	White	100 ft.	5.00	25PF	10 ft. Micro Channel with Recessed Reinforced Grate Area, Parallel Drain Slots with UV inhibitor. Open surface area 1.00 square inch per linear foot. 3.06 GPM per foot. PVC.	
8002	10' Long Micro Channel	Sand	100 ft.	5.00	25PF		
8003	10' Long Micro Channel	Gray	100 ft.	5.00	25PF		
	Includes 1 coupling. (see page 79), ADA Compliant/Heel-proof.						

Micro Accessories

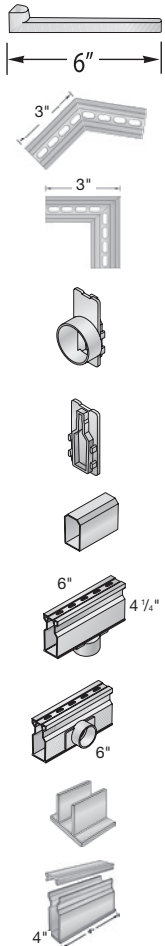



Part No.	Description	Color	Pkg. Qty.	Wt. Ea. (lbs.)	Product Class
230	6" Channel Installation Stake	Gray	24	0.04	25PF
8301	Micro Channel 45° Elbow	White	5	0.30	25PF
8302	Micro Channel 45° Elbow	Sand	5	0.30	25PF
8303	Micro Channel 45° Elbow	Gray	5	0.30	25PF
8381	Micro Channel 90° Elbow	White	5	0.40	25PF
8382	Micro Channel 90° Elbow	Sand	5	0.40	25PF
8383	Micro Channel 90° Elbow	Gray	5	0.40	25PF
8461	Micro 1 1/2" Sch. 40 Spigot End Outlet	White	10	0.10	25PF
8462	Micro 1 1/2" Sch. 40 Spigot End Outlet	Sand	10	0.10	25PF
8463	Micro 1 1/2" Sch. 40 Spigot End Outlet	Gray	10	0.10	25PF
8471	Micro End Plug	White	20	0.05	25PF
8472	Micro End Plug	Sand	20	0.05	25PF
8473	Micro End Plug	Gray	20	0.05	25PF
8481	Micro Channel Couplings only Fits inside channel	White	20	0.10	25PF
8501	Micro 1 1/2" Sch. 40 Spigot Bottom Outlet	White	10	0.35	25PF
8502	Micro 1 1/2" Sch. 40 Spigot Bottom Outlet	Sand	10	0.35	25PF
8503	Micro 1 1/2" Sch. 40 Spigot Bottom Outlet	Gray	10	0.35	25PF
8511	Micro 1 1/2" Sch. 40 Spigot Side Outlet	White	10	0.35	25PF
8512	Micro 1 1/2" Sch. 40 Spigot Side Outlet	Sand	10	0.35	25PF
8513	Micro 1 1/2" Sch. 40 Spigot Side Outlet	Gray	10	0.35	25PF
8601	Micro Hold-Down Clips Use with Channel Stakes to hold channel in place	White	20	0.10	25PF
8651	Micro Channel Cleanout	White	10	0.30	25PF
8652	Micro Channel Cleanout	Sand	10	0.30	25PF
8653	Micro Channel Cleanout	Gray	10	0.30	25PF

PROFILE CHANNEL DRAINS

Slim Channel Drains

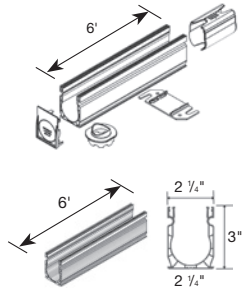
Excellent for light duty applications, including residential pools, concrete and paver patios, spas, walkways and paver landscapes.



Part No.	Description	Color	Pkg. Qty.	Wt. Ea. (lbs.)	Product Class	Specifications
9206SKIT	6 ft. Slim Channel Kits with sand plastic grates	Sand	15 EA (90 LF)	4.2	25PF	2.25" wide Channel Drain Kits & Assemblies
9206GKIT	6 ft. Slim Channel Kits with gray plastic grates Kits include 6 ft. channel, 2 slotted grates, 2 end caps/outlets, 2 anchor clips, 1 coupling & 1 bottom outlet	Gray	15 EA (90 LF)	4.2	25PF	
9209WHITE	9 ft. Slim Channel & Grate Assembly	White	10 EA (90 LF)	5.58	25PF	End & bottom outlets fit 1-1/2" Schedule 40 pipe
9209SAND	9 ft. Slim Channel & Grate Assembly	Sand	10 EA (90 LF)	5.58	25PF	
9209GRAY	9 ft. Slim Channel & Grate Assembly Assemblies include 9 ft. channel and 3 slotted grates	Gray	10 EA (90 LF)	5.58	25PF	PVC Channel with UV inhibitor
9206	6 ft. Slim Channel	Black	15 EA (90 LF)	3.00	25PF	See related specifications for 9241, 9242 & 9243 plastic slotted grates
9209	9 ft. Slim Channel	Black	10 EA (90 LF)	4.5	25PF	
	(see page 79).					

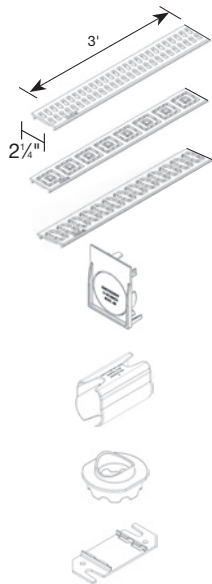

Part No.	Description	Color	Pkg. Qty.	Wt. Ea. (lbs.)	Product Class	Specifications
9241	3 ft. Slim Channel Grate	White	30 EA (90 LF)	0.36	25PF	3 ft polypropylene channel grate with UV inhibitor. Open Surface Area 7.01 square inches per foot. 21.44 GPM per foot.
9242	3 ft. Slim Channel Grate	Sand	30 EA (90 LF)	0.36	25PF	
9243	3 ft. Slim Channel Grate	Gray	30 EA (90 LF)	0.36	25PF	
9251	3 ft. Slim Channel Grate Square	White	30 EA (90 LF)	0.36	25PF	3 ft Polypropylene Decorative Square Channel Grate with UV inhibitor. Open Surface Area 5.73 square inches per foot. 21.44 GPM per foot.
9252	3 ft. Slim Channel Grate Square	Sand	30 EA (90 LF)	0.36	25PF	
9253	3 ft. Slim Channel Grate Square	Gray	30 EA (90 LF)	0.36	25PF	
9261	3 ft. Slim Channel Grate Chain	White	30 EA (90 LF)	0.36	25PF	3 ft Polypropylene Decorative Chain Channel Grate with UV inhibitor. Open Surface Area 5.73 square inches per foot. 21.44 GPM per foot.
9262	3 ft. Slim Channel Grate Chain	Sand	30 EA (90 LF)	0.36	25PF	
9263	3 ft. Slim Channel Grate Chain	Gray	30 EA (90 LF)	0.36	25PF	
	(see page 79).					

Part No.	Description	Color	Pkg. Qty.	Wt. Ea. (lbs.)	Product Class	Specifications
9247	Slim Channel End Cap/Outlet	Black	20 EA	0.04	25PF	End & bottom outlets fit 1-1/2" Schedule 40 pipe
9248	Slim Channel Coupling*	Black	20 EA	0.08	25PF	
9250	Slim Channel Bottom Outlet	Black	10 EA	0.04	25PF	
9270	Slim Channel Anchor Clip	Black	20 EA	0.04	25PF	
9301	Slim Channel Fab 45	White	1 EA	0.29	25PF	
9302	Slim Channel Fab 45	Sand	1 EA	0.29	25PF	
9303	Slim Channel Fab 45	Gray	1 EA	0.29	25PF	
9371	Slim Channel Fab Tee	White	1 EA	0.41	25PF	
9372	Slim Channel Fab Tee	Sand	1 EA	0.41	25PF	
9373	Slim Channel Fab Tee	Gray	1 EA	0.41	25PF	
9381	Slim Channel Fab 90	White	1 EA	0.35	25PF	
9382	Slim Channel Fab 90	Sand	1 EA	0.35	25PF	
9383	Slim Channel Fab 90	Gray	1 EA	0.35	25PF	

* Channel fittings require channel couplings.

CHANNEL & TRENCH DRAINS

PROFILE CHANNEL DRAINS

Mini Channel™ Drains

Excellent for light-duty applications including residential pools, concrete and paver patios, spas and tennis courts.

CHANNEL & TRENCH DRAINS

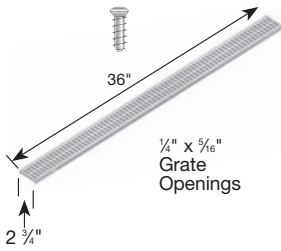

Part No.	Description	Color	Pkg. Qty.	Wt. Ea. (lbs.)	Product Class	Specifications
529	Stainless Steel Screws, FH #4 x 5/8"	Steel	64/Bag	0.10	25PF	3 ft. Structural Foam Polyolefin Channel Grate with UV inhibitor. Open surface area 9.90 square inches per foot. 30.29 GPM per foot.
540	3' Channel Grate	White	48 ft.	0.66	25PF	
541	3' Channel Grate	Gray	48 ft.	0.66	25PF	
542	3' Channel Grate	Green	48 ft.	0.66	25PF	
543	3' Channel Grate	Black	48 ft.	0.66	25PF	
544	3' Channel Grate	Sand	48 ft.	0.66	25PF	
551	3' Channel Grate	Brick Red	48 ft.	0.66	25PF	
 Requires 4 screws per Grate. (see page 79). ADA Compliant/Heel-proof.						

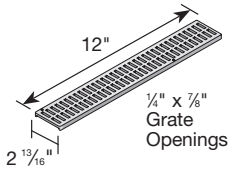

Part No.	Description	Color	Pkg. Qty.	Wt. Ea. (lbs.)	Product Class	Specifications
552B	1' Brass Channel Grate	Satin Brass	12	1.25	25PF	1 ft. Mini Channel Solid Brass Grate with brass screws. Open surface area 9.20 square inches per foot. 28.14 GPM per foot.
553PB	1' Brass Channel Grate	Polished Brass	12	1.25	25PF	
 Fits #500 Mini Channel. (see page 79). ADA Compliant/Heel-proof.						

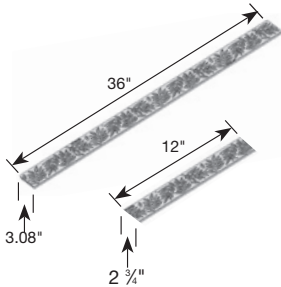

Part No.	Description	Color	Pkg. Qty.	Wt. Ea. (lbs.)	Product Class	Specifications
846	Stainless Steel Screws, FH #4 x 1"	Steel	40/Bag	0.10	25PF	3 ft. Structural Foam Polyolefin botanical pattern Channel Grate with UV inhibitor. Open surface area 5.44 square inches per foot. 16.64 GPM per foot.
554S	3' Botanical Channel Grate	Sand	16	0.89	25PF	
554GY	3' Botanical Channel Grate	Gray	16	0.89	25PF	
554	3' Botanical Channel Grate	Black	16	0.89	25PF	
554CI	1' Botanical Cast Iron Channel Grate	Black*	1	1.82	25PF	1 ft. Mini Channel botanical Cast Iron Channel Grate. Open surface area 5.39 square inches per foot. 16.49 GPM per foot. Class B load rated.
 Fits #500 Mini Channel. (see page 79). ADA Compliant. *Painted for shipping & display only; grate will form iron-oxide patina						

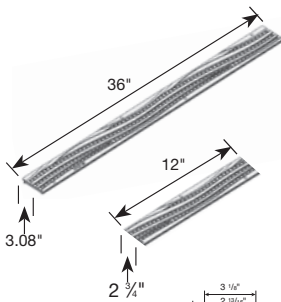

Part No.	Description	Color	Pkg. Qty.	Wt. Ea. (lbs.)	Product Class	Specifications
846	Stainless Steel Screws, FH #4 x 1"	Steel	40/Bag	0.10	25PF	3 ft. Structural Foam Polyolefin wave pattern Channel Grate with UV inhibitor. Open surface area 5.73 square inches per foot. 17.54 GPM per foot.
555S	3' Wave Channel Grate	Sand	16	0.88	25PF	
555GY	3' Wave Channel Grate	Gray	16	0.88	25PF	
555	3' Wave Channel Grate	Black	16	0.88	25PF	
555CI	1' Wave Cast Iron Channel Grate	Black*	1	1.30	25PF	1 ft. Mini Channel Wave Cast Iron Channel Grate. Open surface area 4.11 square inches per foot. 12.56 GPM per foot. Class B load rated.
 Fits #500 Mini Channel. (see page 79). ADA Compliant. *Painted for shipping & display only; grate will form iron-oxide patina						

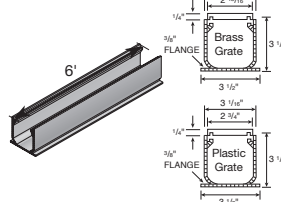

Part No.	Description	Color	Pkg. Qty.	Wt. Ea. (lbs.)	Product Class	Specifications
500	6' Mini Channel Drain	Gray	48 ft.	3.26	25PF	6 ft. PVC Mini Channel Drain with inverse flying-buttress design, bottom flange, patented honeycomb reinforced walls and UV inhibitor.
500S	6' Mini Channel Drain	Sand	48 ft.	3.26	25PF	
Grate should be recessed 1/8" below finish grade in non-traffic applications. Grate should be recessed 1/4" in traffic applications.						

PROFILE CHANNEL DRAINS

Mini Channel Accessories

Excellent for light duty applications, including residential pools, concrete and paver patios, spas and tennis courts.

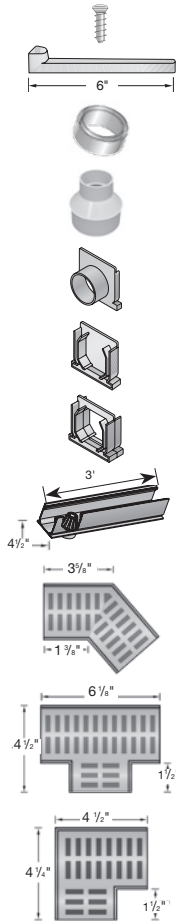

Part No.	Description	Color	Pkg. Qty.	Wt. Ea. (lbs.)	Product Class
529	Stainless Steel Screws, FH #4 x 5/8"	Steel	64/Bag	0.10	25PF
230	6" Channel Installation Stake	Gray	24	0.04	25PF
532	Adapter Bushing for Mini Channel 2" Bottom & End Outlet to 3" S&D Fittings	White	20	0.14	30PV
533	Adapter for Mini Channel 2" Bottom & End Outlet to 4" S&D Fittings	White	20	0.34	30PV
546	Mini Channel End Outlet to 2" Sch. 40 Pipe Fittings	Gray	10	0.15	25PF
546S	Mini Channel End Outlet to 2" Sch. 40 Pipe Fittings	Sand	10	0.15	25PF
547	Mini Channel End Cap	Gray	20	0.12	25PF
547S	Mini Channel End Cap	Sand	20	0.12	25PF
548	Mini Channel Coupling	Gray	20	0.12	25PF
548S	Mini Channel Coupling	Sand	20	0.12	25PF
550	3' Mini Channel Drain with Atrium Strainer and Bottom Outlet to 2" Sch. 40 Pipe Fittings	Gray	6	2.17	25PF
5300	Fabricated 45° Elbow with Grate	Gray	1	0.40	25PF
5303	Fabricated 45° Elbow with Grate	Sand	1	0.40	25PF
5370	Fabricated Tee with Grate	Gray	1	0.50	25PF
5380	Fabricated 90° Elbow with Grate	Gray	1	0.40	25PF
5383	Fabricated 90° Elbow with Grate	Sand	1	0.40	25PF

CHANNEL & TRENCH DRAINS

Profile Channel Paver Installation

NDS Profile Channel Systems and grates are dimensionally compatible with standard 2-3/8" clay and concrete paving systems. Both decorative and standard grate options make Profile Channel an ideal choice for drainage on paver pool decks, patios, plazas, courtyards and parking courts.



PROFILE CHANNEL DRAINS

Spee-D® Channel Drains

Ideal for commercial as well as residential applications. Effective in everything from patios to light vehicular traffic areas.

CHANNEL & TRENCH DRAINS

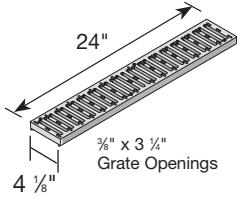

Part No.	Description	Color	Pkg. Qty.	Wt. Ea. (lbs.)	Product Class	Specifications	
229	Stainless Steel Screws, FH #8 X 1" for Spee-D Channel Plastic Slotted Grates	Steel	48/Bag	0.06	25PF	2 ft. Structural Foam Polyolefin Secured Channel Grate with UV inhibitor. Open surface area 16.76 square inches per foot. 51.27 GPM per foot.	
240	2' Channel Slotted Grate	White	24 ft.	1.33	25PF		
241	2' Channel Slotted Grate	Gray	24 ft.	1.33	25PF		
242	2' Channel Slotted Grate	Green	24 ft.	1.33	25PF		
243	2' Channel Slotted Grate	Black	24 ft.	1.33	25PF		
244	2' Channel Slotted Grate	Sand	24 ft.	1.33	25PF		
251	2' Channel Slotted Grate	Brick Red	24 ft.	1.42	25PF		
254	2' Galvanized Steel Channel Grate	Galvanized Steel	24 ft.	1.90	25PF		
	(see page 79). ADA Compliant.						

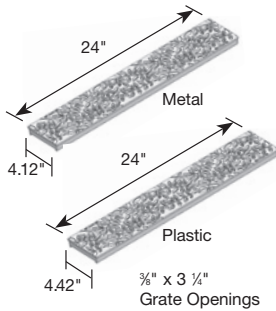

Part No.	Description	Color	Pkg. Qty.	Wt. Ea. (lbs.)	Product Class	Specifications	
829	Stainless Steel Screws, FH #6 X 1-1/4" for Spee-D Channel Decorative Plastic Grates	Steel	40/Bag	0.15	25PF	2 ft. Structural Foam Polyolefin decorative botanical Channel Grate with UV inhibitor. Open surface area 7.78 square inches per foot. 23.80 GPM per foot.	
252S	2' Channel Botanical Grate	Sand	24 ft.	1.74	25PF		
252GY	2' Channel Botanical Grate	Gray	24 ft.	1.74	25PF		
252	2' Channel Botanical Grate	Black	24 ft.	1.74	25PF		
252CI	2' Cast Iron Channel Botanical Grate	Black*	2 ft.	7.06	25PF		
229	Stainless Steel Screws, FH #8 x 1" for Spee-D Channel Decorative Iron Grates	Steel	48	0.06	25PF		
	(see page 79). ADA Compliant.						
	*Painted for shipping & display only; grate will form iron-oxide patina						

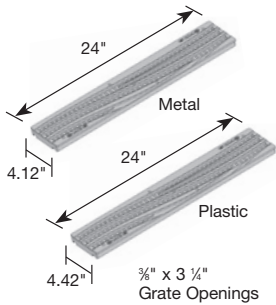

Part No.	Description	Color	Pkg. Qty.	Wt. Ea. (lbs.)	Product Class	Specifications	
829	Stainless Steel Screws, FH #6 X 1-1/4" for Spee-D Channel Decorative Plastic Grates	Steel	40/Bag	0.15	25PF	2 ft. Structural Foam Polyolefin decorative wave Channel Grate with UV inhibitor. Open surface area 7.78 square inches per foot. 23.80 GPM per foot.	
253S	2' Channel Wave Grate	Sand	24 ft.	1.84	25PF		
253GY	2' Channel Wave Grate	Gray	24 ft.	1.84	25PF		
253	2' Channel Wave Grate	Black	24 ft.	1.84	25PF		
253CI	2' Cast Iron Channel Wave Grate	Black*	2 ft.	7.52	25PF		
229	Stainless Steel Screws, FH #8 x 1" for Spee-D Channel Decorative Iron Grates	Steel	48	0.06	25PF		
	(see page 79). ADA Compliant.						
	*Painted for shipping & display only; grate will form iron-oxide patina						

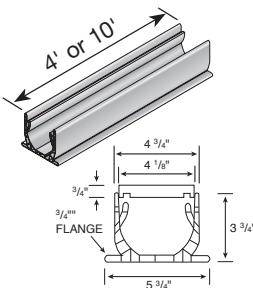

Part No.	Description	Color	Pkg. Qty.	Wt. Ea. (lbs.)	Product Class	Specifications
400	4' Spee-D Channel Drain	Gray	24 ft.	4.83	25PF	PVC Channel Drain with Inverse Flying Buttress design, bottom flange, patented honeycomb reinforced walls and UV inhibitor.
400-10	10' Spee-D Channel Drain	Gray	60 ft.	11.00	25PF	
400-10WH	10' Spee-D Channel Drain Assembly with pre-fastened Gray Plastic Grates	Gray	60 ft.	17.5	25PF	
400-10MTL	10' Spee-D Channel Drain Assembly with pre-fastened Galvanized Steel Grates	Galvanized Steel	40 ft.	20.5	25PF	
	Grate should be recessed 1/8" below finish grade in non-traffic applications. Grate should be recessed 1/4" below finished grade in traffic applications.					

PROFILE CHANNEL DRAINS

Spee-D® Accessories

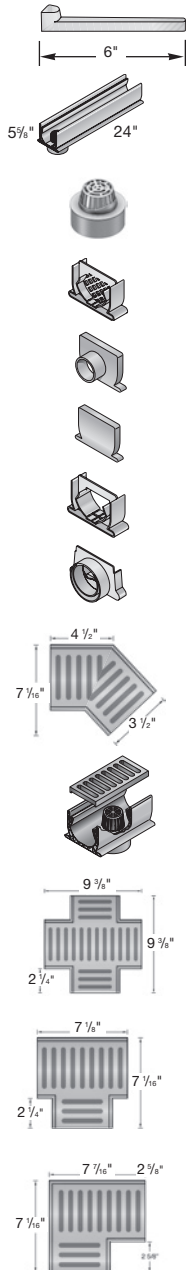

Part No.	Description	Color	Pkg. Qty.	Wt. Ea. (lbs.)	Product Class
230	6" Channel Installation Stake	Gray	24	0.04	25PF
234	2' Spee-D Channel Drain with Atrium Strainer and Bottom Outlet to 3" and 4" Sewer and Drain Fittings	Gray	12	2.67	25PF
2350	Spee-D Channel Bottom Outlet insert to 3" and 4" Sewer and Drain Fittings	Gray	5	0.30	25PF
245	Spee-D Channel Strainer Coupling	Gray	20	0.35	25PF
246	Spee-D Channel End Outlet to 2" Sch. 40 Pipe Fittings	Gray	10	0.40	25PF
247	Spee-D Channel End Cap	Gray	10	0.40	25PF
248	Spee-D Channel Coupling	Gray	20	0.40	25PF
249	Spee-D Channel Offset End Outlet to 3" Sewer and Drain Pipe and 4" Sewer and Drain Fittings	Gray	10	0.50	25PF
2301	Fabricated 45° Elbow with Grate	Gray	1	2.00	25PF
2351	7" Fabricated Grate 4" Bottom Outlet with Grate	Gray	1	1.70	25PF
2361	Fabricated Cross and Grate	Gray	1	3.00	25PF
2371	Fabricated Tee with Grate	Gray	1	3.00	25PF
2381	Fabricated 90° Elbow with Grate	Gray	1	3.00	25PF

CHANNEL & TRENCH DRAINS

PRO SERIES CHANNEL DRAINS



NDS Pro Series is a lightweight channel drain system with interlocking joints and a modular design, so systems are flexible and connections are made quickly and easily.

Load Rated: Up to NDS Class C with appropriate grate.
For Residential and Commercial applications.

The NDS Pro Series modular design offers flexibility as each section of channel can be snapped together for longer runs or divided down to lengths as short as 4" for smaller, interlocking sections.

Lightweight parts connect easily to sewer and drain pipe and fittings or Sch 40 pipe and fittings, and side and bottom outlets can be connected anywhere along the channel run.

- Channel-to-channel clips for reduced motion during installation
- Rebar clips instead of lower mount clips for an easier install
- Side ribs for increased strength
- Lay-flat design stabilizes channel during installation
- Thicker channel walls for additional strength
- Rebar size #4 or #5

All this, and the channel still fits easily with all grates and end connectors.

5" Pro Series
Deep Profile Channel
shown #800

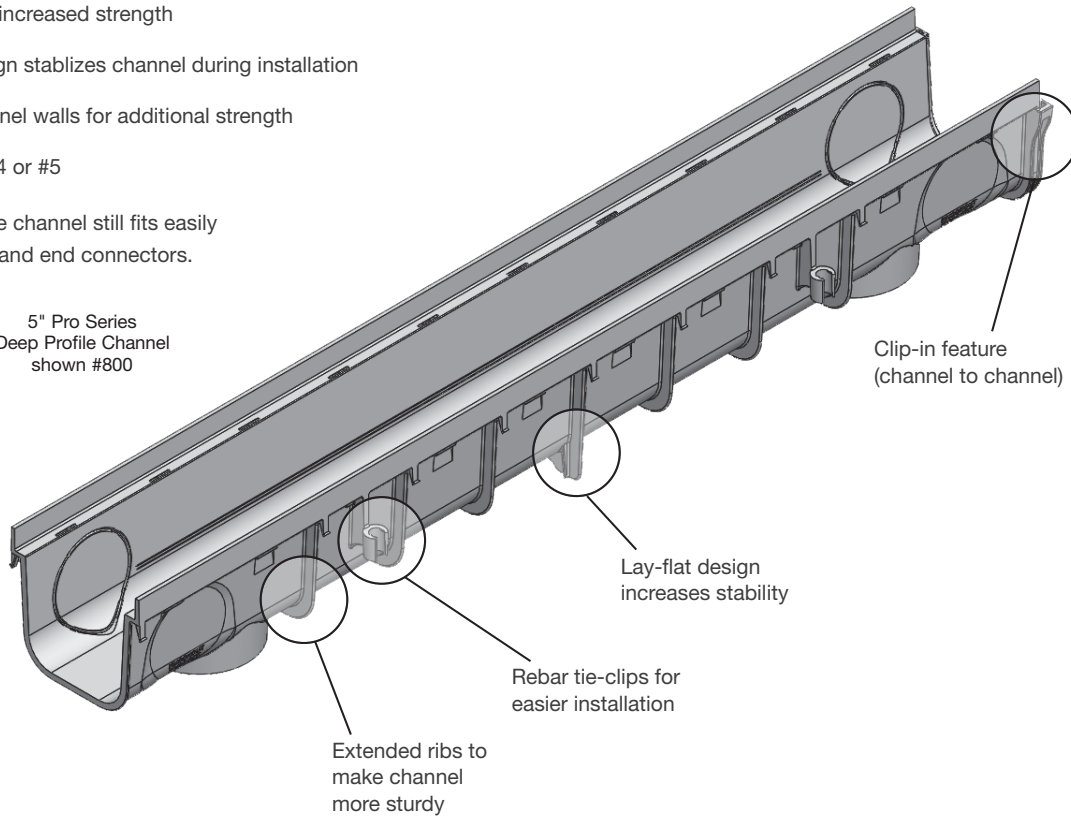

PRO SERIES CHANNEL DRAINS

Details

- Create a channel as long as you need, or reduce to lengths as short as 4" for smaller, interlocking sections.
- End cap/Knockout end and outlet fitting simplify assembly and installation.
- Flexible and easy: side and bottom outlets can be inserted at any location along the channel run.
- Available in four widths: 3", 5", 8" and 12"
- Available in two depths: deep for heavy flows, shallow for slabs or where little fall depth is available.
- Modular design comes in 1/2 meter (19 11/16") and 1 meter (39 3/8") pieces with interlocking end joints.
- Joints eliminate couplings and are specially designed to withstand concrete expansion and contraction.

Materials & Standards

- Polypropylene (3" & 5" channels) and polyvinyl chloride (8" & 12" channels) create a structurally-compact, water-tight channel.
- All parts contain UV inhibitors to prevent fading and cracking.

Load Recommendations

- Pedestrian Grates offer heel-proof pattern.
- Polyolefin Light Vehicular Grate for use in areas with passenger vehicles and light trucks with speeds less than 20 MPH.
- Load Star or Ductile Channel Grates for heavy-duty traffic.
- See individual products for details.

Pre-Assembled Channel Drain Systems

Our Modular Pro Series channel drains also come in pre-assembled kits to decrease installation time. They act as perimeter drains, quickly removing water from hardscapes and directing it away from building structures.

The 3" and 5" wide pre-assembled channel drain kits include a one-meter (39-3/8") channel drain and grate, end outlet, and end cap. A bottom outlet is built into each channel section. This allows for easy ordering and less inventorying, as everything is included under one part number.

Our unique Pro Series interlocking channel design allows each channel to securely lock to the next for a secure, tight fit, with no couplings required. The pre-assembled Pro Series channel drains are a great solution for your drainage needs.

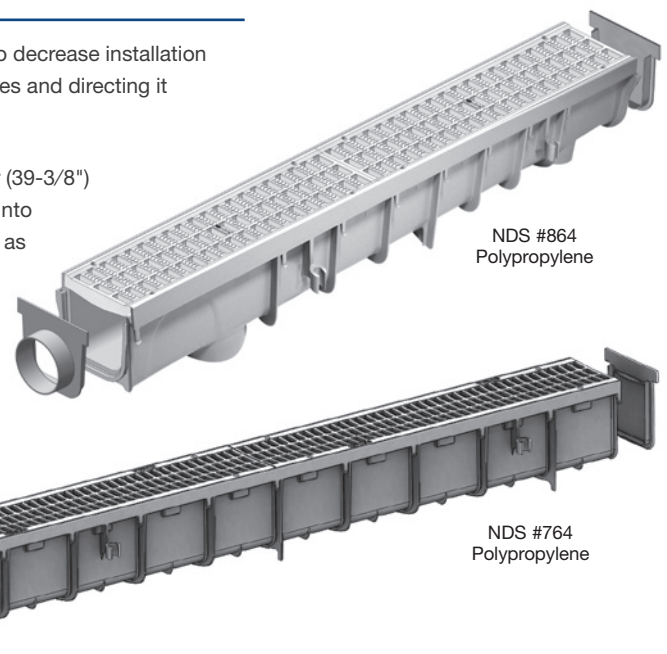
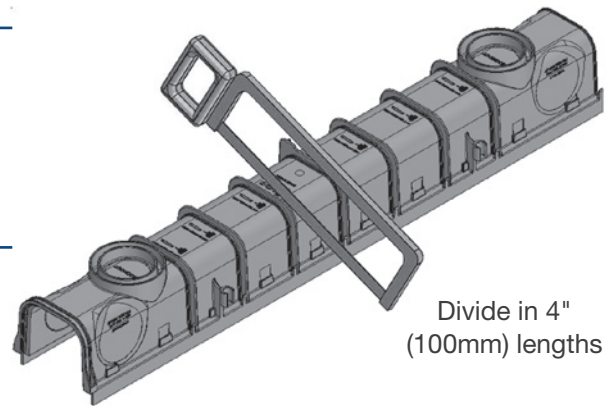

PRO SERIES CHANNEL DRAINS

CHANNEL & TRENCH DRAINS

3" Pro Series Channel™ Drains

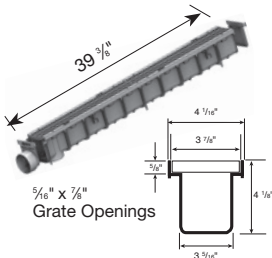

Part No.	Description	Color	Pkg. Qty.	Wt. Ea. (lbs.)	Product Class	Specifications
764	3" x 1 Meter Light Traffic Channel Grate & Channel Drain Kit	Light Gray	10	3.50	25IN	3" wide Light Traffic Channel Grate and Channel Drain with mechanical interlocking joints and UV inhibitors. Open surface area 23.63 square inches per foot. 76.85 GPM per foot.
	Includes 1 end outlet (#713) and 1 end cap (#712). Bottom and end outlets fit 3" S&D fittings. Grate should be recessed 1/8" below finish grade in non-traffic applications. Grate should be recessed 1/4" in traffic applications. (see page 79). ADA Compliant.					

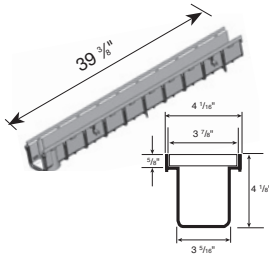

Part No.	Description	Color	Pkg. Qty.	Wt. Ea. (lbs.)	Product Class	Specifications
710	3" x 1 Meter Channel Drain*	Light Gray	12	1.90	25IN	3" wide Light Traffic Channel with mechanical interlocking joints and UV inhibitors. Polypropylene.
	Bottom outlet fits 3" S&D fittings. Grate should be recessed 1/8" below finish grade in non-traffic applications. Grate should be recessed 1/4" in traffic applications. *Produced under license of First Plast S.R.L.- Italy. (see page 79). ADA Compliant.					

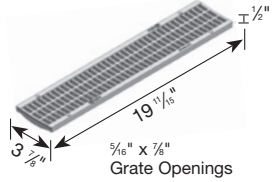

Part No.	Description	Color	Pkg. Qty.	Wt. Ea. (lbs.)	Product Class	Specifications
714	3" x 20" Light Traffic Channel Grate*	Light Gray	24	0.70	25IN	3" wide Light Traffic Channel Grate. Open surface area 23.63 square inches per foot. 72.29 GPM per foot. Polypropylene.
	Requires 4 #229 screws. *Produced under license of First Plast S.R.L.- Italy. (see page 79). ADA Compliant.					



Part No.	Description	Color	Pkg. Qty.	Wt. Ea. (lbs.)	Product Class	Specifications
713	3" End Cap/End Outlet	Light Gray	12	0.10	25IN	3" Channel End Cap/End Outlet. Polypropylene.
	Fits 3" Fittings.					

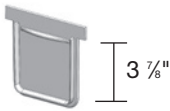

Part No.	Description	Color	Pkg. Qty.	Wt. Ea. (lbs.)	Product Class	Specifications
712	3" End Cap	Light Gray	20	0.05	25IN	3" Channel End Cap. Polypropylene.



Part No.	Description	Color	Pkg. Qty.	Wt. Ea. (lbs.)	Product Class	Specifications
229	Stainless Steel Screws FH H8 x 1"	Steel	48/Bag	0.06	25PF	

PRO SERIES CHANNEL DRAINS

5" Pro Series Channel™ Drains

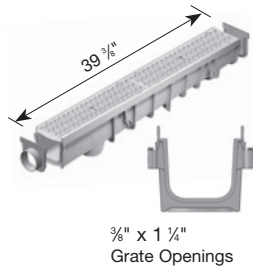

Part No.	Description	Color	Pkg. Qty.	Wt. Ea. (lbs.)	Product Class	Specifications
864	5" x 1 Meter Light Traffic Channel Kit with Light Gray Plastic Grates. Includes 1 End Outlet & 1 Cap	Light Gray	9	5.67	25IN	5" wide Light Traffic Channel Drain Kits and Displays.
864DISPLAY	5" Pro Series Channel Kit with Plastic Grate Display (9 kits)	Light Gray	1 box = 9 kits	51.03	25IN	See related specifications for 800 Channel and 814 & 824 Grates.
864GRTL	5" x 1 Meter Light Traffic Channel Kit with Galvanized Steel Grates. Includes 1 End Outlet & 1 Cap	Galvanized Steel	9	6.15	25IN	Includes channel, grates, screws, end cap and end cap/outlet.
864GRTLDISP	5" Pro Series Channel Kit with Steel Grate Display (9 kits)	Galvanized Steel	1 box = 9 kits	55.35	25IN	DISP includes 9 kits either light gray plastic or galvanized steel grates
Grate should be recessed 1/8" below finish grade in non-traffic applications. Grate should be recessed 1/4" below finish grade in traffic applications. (see page 79). ADA Compliant.						

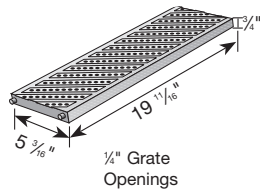

Part No.	Description	Color	Pkg. Qty.	Wt. Ea. (lbs.)	Product Class	Specifications
826	5" x 20" Pedestrian Traffic Channel Grate	Light Gray	10	1.00	25IN	5" wide UV-protected Structural Foam Polyolefin Pedestrian Traffic Channel Grate. Open surface area 4.86 square inches per foot. 24.26 GPM per foot.
Requires #829 screws. (see page 79). ADA Compliant/Heelproof.						

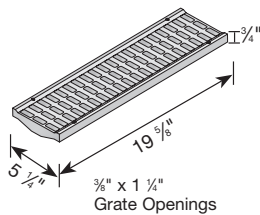

Part No.	Description	Color	Pkg. Qty.	Wt. Ea. (lbs.)	Product Class	Specifications
814	5" x 20" Light Traffic Channel Grate	Light Gray	10	1.16	25IN	5" wide Structural Foam Polyolefin Light Traffic Channel Grate with UV inhibitors. Open surface area 23.52 square inches per foot. 71.95 GPM per foot.
815	5" x 20" Light Traffic Channel Grate	Green	10	1.16	25IN	
816	5" x 20" Light Traffic Channel Grate	Black	10	1.16	25IN	
817	5" x 20" Light Traffic Channel Grate	Sand	10	1.16	25IN	
818	5" x 20" Light Traffic Channel Grate	Brick Red	10	1.16	25IN	
819	5" x 20" Light Traffic Channel Grate	White	10	1.16	25IN	
824	5" x 20" Galvanized Steel Light Traffic Channel Grate	Galvanized Steel	10	1.14	25IN	2 ft. Galvanized Steel Channel Grate. Open surface area 19.32 square inches per foot. 59.1 GPM per foot.
Requires #829 screws. (see page 79). ADA Compliant.						

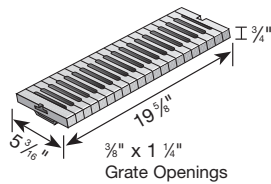

Part No.	Description	Color	Pkg. Qty.	Wt. Ea. (lbs.)	Product Class	Specifications
828	5" x 20" Load Star Heavy Traffic Channel Grate	Gray	10	2.35	25IN	5" wide UV-protected high-impact glass-reinforced nylon Heavy Traffic Channel Grate. Open surface area 15.92 square inches per foot. 48.70 GPM per foot.
Requires 4 screws per grate. Requires #829 screws. (see page 79)						

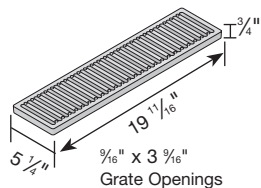

Part No.	Description	Color	Pkg. Qty.	Wt. Ea. (lbs.)	Product Class	Specifications
823	5" x 20" Ductile Channel Grate	Black*	1	12.30	25IN	5" wide heavy-duty Ductile Heavy Traffic Channel Grate. Open surface area 22.90 square inches per foot. 70.05 GPM per foot.
Requires #829 screws. (see page 79). ADA Compliant. *Painted for shipping & display only; grate will form iron-oxide patina						



Part No.	Description	Color	Pkg. Qty.	Wt. Ea. (lbs.)	Product Class	Specifications
829	Stainless Steel Screws FH #6 x 1 1/4"	Steel	40/Bag	0.15	25PF	

PRO SERIES CHANNEL DRAINS

5" Pro Series Channel™ Drains (continued)

CHANNEL & TRENCH DRAINS

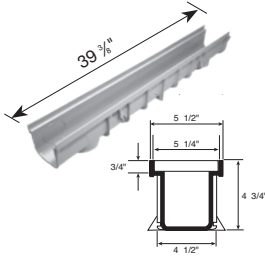

Part No.	Description	Color	Pkg. Qty.	Wt. Ea. (lbs.)	Product Class	Specifications
800	5" x 1 Meter Deep Profile Channel Drain	Light Gray	10	4.00	25IN	5" wide Deep Profile Channel Drain with interlocking joints, side rebar clips, integrated side and bottom outlet Knockouts. Polypropylene.
	New Integrated side outlet Knockouts fit 3" S&D pipe Integrated Knockout bottom outlet fits 3" and 4" S&D fittings. Grate should be recessed 1/8" below finish grade in non-traffic applications. Grate should be recessed 1/4" in traffic applications.					

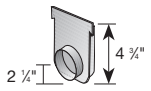

Part No.	Description	Color	Pkg. Qty.	Wt. Ea. (lbs.)	Product Class	Specifications
812	5" Deep Profile End Cap	Light Gray	10	0.13	25IN	5" wide Deep Profile End Cap. PVC.

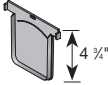

813	5" Deep Profile End Cap/3" S&D Hub & 4" S&D SPT Knockout End Outlet	Light Gray	10	0.40	25IN	5" wide Deep Profile End Cap/End Outlet. PVC.
-----	---------------------------------------------------------------------	------------	----	------	------	-----------------------------------------------

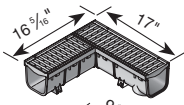

861	5" Deep Profile Grate & Channel Drain 90° Elbow	Light Gray	1	3.44	25IN	
-----	-------------------------------------------------	------------	---	------	------	--

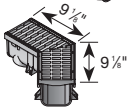

862	5" Deep Profile Grate & Channel Drain 45° Elbow	Light Gray	1	3.44	25IN	
-----	-------------------------------------------------	------------	---	------	------	--



PSRC-864	Quik-Turn™ 5" Deep Radius Coupling Provides a 6 degree bend left or right	Light Gray	9	0.30	25IN	
----------	---------------------------------------------------------------------------	------------	---	------	------	--

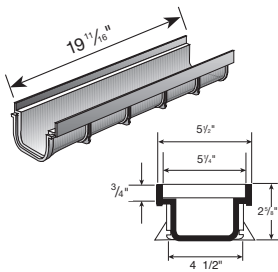

Part No.	Description	Color	Pkg. Qty.	Wt. Ea. (lbs.)	Product Class	Specifications
820	5" x 20" Shallow Profile Channel Drain*	Light Gray	10	1.35	25IN	5" wide Shallow Profile UV-protected high-impact PVC Channel Drain with mechanical interlocking joint.
	Grate should be recessed 1/8" below finish grade in non-traffic applications. Grate should be recessed 1/4" in traffic applications. *Produced under license of First Plast S.R.L. - Italy.					

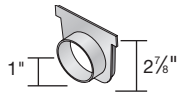

Part No.	Description	Color	Pkg. Qty.	Wt. Ea. (lbs.)	Product Class	Specifications
821	5" Shallow Profile End Cap/1-1/2" Sch. 40 SPT Knockout End Outlet*	Light Gray	10	0.15	25IN	5" wide Shallow Profile high-impact PVC End Cap/End Outlet.
	End Outlet fits 1-1/2" Schedule 40 fittings. *Produced under license of First Plast S.R.L. - Italy.					

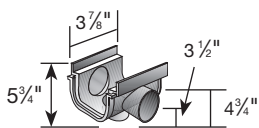

Part No.	Description	Color	Pkg. Qty.	Wt. Ea. (lbs.)	Product Class	Specifications
822	5" Shallow Profile 3" S&D SPT Bottom Outlet/1 1/2" Sch. 40 Hub Side Outlet	Light Gray	10	0.60	25IN	5" wide Shallow Profile high-impact PVC Bottom/Side Outlet.
	Side Outlets fit 1-1/2" Schedule 40 pipe Bottom Outlet fits 3" S&D fittings					

PRO SERIES CHANNEL DRAINS

8" Pro Series Channel™ Drains

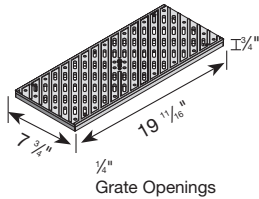

Part No.	Description	Color	Pkg. Qty.	Wt. Ea. (lbs.)	Product Class	Specifications
836	8" x 20" Pedestrian Traffic Channel Grate	Light Gray	1	1.55	25IN	8" wide UV-protected Structural Foam Polyolefin Pedestrian Traffic Channel Grate. Open surface area 13.82 square inches per foot. 42.28 GPM per foot.
	Requires #829 screws. 4 screws per grate. (see page 79). ADA Compliant/Heelproof.					

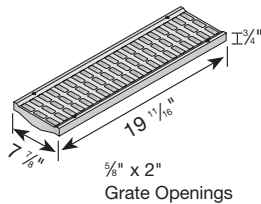

Part No.	Description	Color	Pkg. Qty.	Wt. Ea. (lbs.)	Product Class	Specifications
837	8" x 20" Light Traffic Channel Grate	Light Gray	1	3.00	25IN	8" wide UV-protected Structural Foam Polyolefin Light Traffic Channel Grate. Open surface area 30.28 square inches per foot. 92.63 GPM per foot.
	Requires #829 screws. 4 screws per grate. (see page 79)					

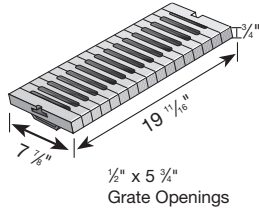

Part No.	Description	Color	Pkg. Qty.	Wt. Ea. (lbs.)	Product Class	Specifications
838	8" x 20" Load Star Heavy Traffic Channel Grate*	Gray	1	3.59	25IN	8" wide UV-protected high-impact glass-reinforced nylon Heavy Traffic Channel Grate. Open surface area 30.85 square inches per foot. 94.37 GPM per foot.
	Requires #829 screws. 4 screws per grate. *Produced under license of First Plast S.R.L. - Italy. (see page 79). ADA Compliant.					

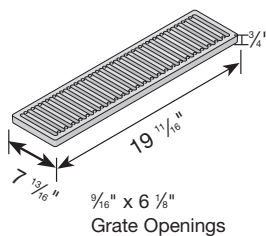

Part No.	Description	Color	Pkg. Qty.	Wt. Ea. (lbs.)	Product Class	Specifications
888	8" x 20" Ductile Channel Grate	Black*	1	22.24	25IN	8" wide heavy-duty Ductile Heavy Traffic Channel Grate. Open surface area 23.80 square inches per foot. 71.28 GPM per foot.
	*Painted for shipping & display only; grate will form iron-oxide patina #829 screws may be used. 4 screws per grate. (see page 79)					



Part No.	Description	Color	Pkg. Qty.	Wt. Ea. (lbs.)	Product Class	Specifications
829	Stainless Steel Screws FH #6 x 1 1/4"	Steel	40/Bag	0.15	25PF	

PRO SERIES CHANNEL DRAINS

8" Pro Series Channel™ Drains (continued)

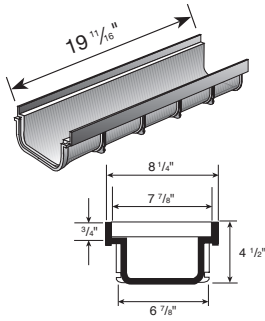

Part No.	Description	Color	Pkg. Qty.	Wt. Ea. (lbs.)	Product Class	Specifications
830	8" x 20" Shallow Profile Channel Drain*	Light Gray	1	2.00	25IN	8" wide Shallow Profile high-impact PVC Channel Drain with mechanical interlocking joints and UV inhibitors.
Grate should be recessed 1/8" below finish grade in non-traffic applications. Grate should be recessed 1/4" in traffic applications. *Produced under license of First Plast S.R.L. - Italy.						

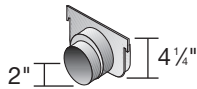

Part No.	Description	Color	Pkg. Qty.	Wt. Ea. (lbs.)	Product Class	Specifications
831	8" Shallow Profile End Cap/ 3" S&D SPT Knockout End Outlet*	Light Gray	1	0.49	25IN	8" wide Shallow Profile high-impact PVC End Cap/ End Outlet.
End Outlet fits 3" Sewer and Drain fittings *Produced under license of First Plast S.R.L. - Italy.						

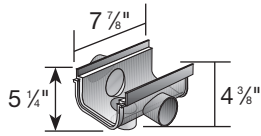

Part No.	Description	Color	Pkg. Qty.	Wt. Ea. (lbs.)	Product Class	Specifications
832	8" Shallow Profile 3" S&D SPT Side Outlet*	Light Gray	1	1.38	25IN	8" wide Shallow Profile high-impact PVC Bottom/ Side Outlets with bottom adapter.
Bottom outlet fits 4" S&D pipe, side outlets fit 3" Sewer and Drain fittings. *Produced under license of First Plast S.R.L. - Italy.						

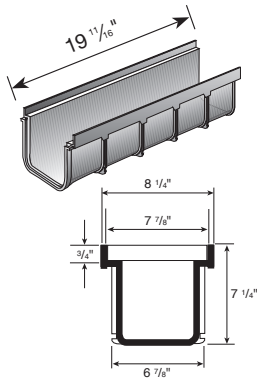

Part No.	Description	Color	Pkg. Qty.	Wt. Ea. (lbs.)	Product Class	Specifications
833	8" x 20" Deep Profile Channel Drain	Light Gray	1	2.80	25IN	8" wide Deep Profile high-impact PVC Channel Drain with mechanical interlocking joints and UV inhibitors.
Grate should be recessed 1/8" below finish grade in non-traffic applications. Grate should be recessed 1/4" in traffic applications.						

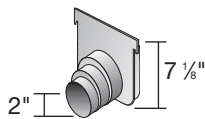

Part No.	Description	Color	Pkg. Qty.	Wt. Ea. (lbs.)	Product Class	Specifications
834	8" Deep Profile End Cap/3"& 4" S&D SPT Knockout End Outlet	Light Gray	10	0.51	25IN	8" wide Deep Profile high-impact PVC End Cap/End Outlet.
End Outlet fits 3" and 4" Sewer and Drain fittings *Produced under license of First Plast S.R.L. - Italy.						

PRO SERIES CHANNEL DRAINS

12" Pro Series Channel™ Drains

CHANNEL & TRENCH DRAINS

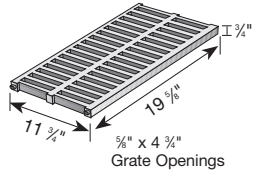

Part No.	Description	Color	Pkg. Qty.	Wt. Ea. (lbs.)	Product Class	Specifications
847	12" x 20" Light Traffic Channel Grate*	Gray	1	4.64	25IN	12" wide UV-protected high-impact PVC Light Traffic Channel Grate. Open surface area 48.77 square inches/foot. 149.19 GPM per foot.
	*Produced under license of First Plast S.R.L.- Italy. (see page 79)					

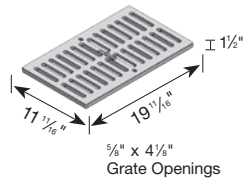

Part No.	Description	Color	Pkg. Qty.	Wt. Ea. (lbs.)	Product Class	Specifications
885	12" x 20" Ductile Iron Heavy Traffic Channel Grate	Black*	1	29.30	25IN	12" Wide Cast Iron Heavy Traffic Channel Grate. Open surface area 46.70 square inches per foot. 142.86 GPM per foot.
	*Painted for shipping & display only; grate will form iron-oxide patina (see page 79)					

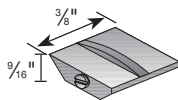

Part No.	Description	Color	Pkg. Qty.	Wt. Ea. (lbs.)	Product Class	Specifications
849	Grate Security Clip*	Gray	10	0.40	25IN	
	For use with 847 and 885 grates and 840 or 843 channels only (2 per grate). Mounts inside channel drain and secures grate. Screw and nut included. *Produced under license of First Plast S.R.L.- Italy.					

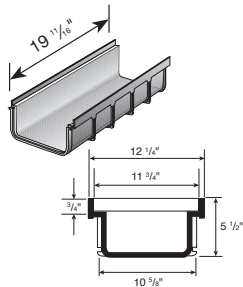

Part No.	Description	Color	Pkg. Qty.	Wt. Ea. (lbs.)	Product Class	Specifications
840	12" x 20" Shallow Profile Channel Drain	Light Gray	1	4.00	25IN	12" wide Shallow Profile UV-protected high-impact PVC Channel Drain with mechanical interlocking joints.
	Grate should be recessed 1/8" below finish grade in non-traffic applications. Grate should be recessed 1/4" in traffic applications.					

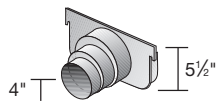

Part No.	Description	Color	Pkg. Qty.	Wt. Ea. (lbs.)	Product Class	Specifications
841	12" Shallow Profile End Cap/End Outlet Knockout with 4" S&D Hub* Fits 4" Sewer and Drain pipe	Light Gray	1	1.00	25IN	12" wide Shallow Profile high-impact PVC End Cap/Outlet with adapter.
	*Produced under license of First Plast S.R.L.- Italy.					

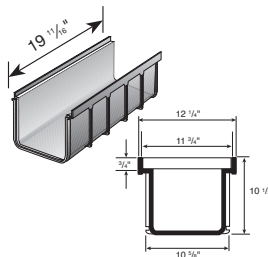

Part No.	Description	Color	Pkg. Qty.	Wt. Ea. (lbs.)	Product Class	Specifications
843	12" x 20" Deep Profile Channel Drain*	Light Gray	1	6.00	25IN	12" wide Deep Profile UV-protected high-impact PVC Channel Drain with mechanical interlocking joints.
	Grate should be recessed 1/8" below finish grade in non-traffic applications. Grate should be recessed 1/4" in traffic applications. *Produced under license of First Plast S.R.L.- Italy.					

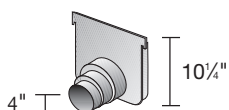

Part No.	Description	Color	Pkg. Qty.	Wt. Ea. (lbs.)	Product Class	Specifications
844	12" Deep Profile End Cap/End Outlet Knockout with 4" S&D Hub* Fits 4" Sewer and Drain pipe	Light Gray	1	1.60	25IN	12" wide Deep Profile high-impact PVC End Cap/Outlet with adapter.
	*Produced under license of First Plast S.R.L.- Italy.					

DURA SLOPE™ TRENCH DRAIN – PRE-SLOPED (PATENTED)



NDS Dura Slope™ is a high-quality quality, dependable, best-in-class trench drain system ideal for a variety of drainage solutions, including driveways, parking areas, warehouses, loading docks, pools, wash down areas and other areas for the interception and collection of surface runoff. Dura Slope™ pre-sloped and neutral trench drain system provides a solution for residential, commercial, industrial and municipal drainage needs.

The NDS Dura Slope™ trench drain system consists of 33 channel sections; 24 pre-sloped sections with 0.7% built in slope and 9 neutral sections. The system also has a catch basin assembly. All Dura Slope™ channel sections are 48" long, grip #3 and #4 rebar and support 6" wide grates. Dura Slope™ channel sections are also available in depths from 4" to 12".

The sloped channel sections enable the Dura Slope™ system to extend to a length of 96 feet with continuous slope. The neutral channel sections can be used for non-sloped system runs or can be used in conjunction with the pre-sloped channel sections for an extended system run of 132 feet. By incorporating central collection using the catch basin assembly, the Dura Slope™ trench drain system can be extended up to 266 feet. The ProFit™ locking system maintains structural integrity during installation, and is a locking device and support for the grates. Each channel section ships with ProFit™, Blank Grate Inserts and grate screws installed.

Details

- Lightweight 4 ft. modular sections
- Easier handling and installation
- Lower freight costs
- 2" radius bottom minimizes debris build-up
- Polyethylene material
- Durable and inexpensive
- Less breakage versus concrete
- High chemical resistance
- Bottom outlet on each channel section
- System versatility
- Requires fewer accessories
- 0.7% built-in slope
- Maintains optimum flow rates throughout system

DURA SLOPE™ TRENCH DRAIN – PRE-SLOPED (PATENTED)

Product Features & Benefits

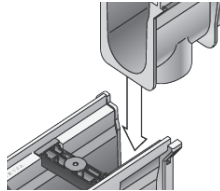

Interlocking tongue and groove joints

- Secures alignment
- Ensures straight channel runs
- Easy assembly and installation

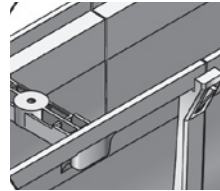

DuraLoc™ integral joint lock

- Prevents joint movement during installation
- No extra clamps or screws needed

Various grating options

- ADA compliant, Heel-Proof options
- Plastic grates
Array of colors
Pedestrian and light traffic rated
- Galvanized & stainless steel
Pedestrian & heavy traffic rated
- Cast & ductile iron
Class D heavy traffic rated (with frame)
- Decorative grates (ductile iron)
Standard black electrostatic coating
or raw iron Class C traffic rated

Lightweight 4 ft. modular sections

- Easier handling and installation
- Lower freight costs

Blank grate insert

- Eliminates use of plywood
- Slides for overlapping of channel sections
- Includes grates screws

Smooth HDPE interior

Virtually no water absorption

HDPE material

- Durable
- Inexpensive
- Less breakage versus concrete
- Chemical resistance

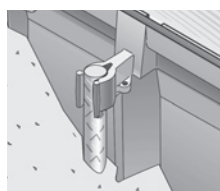
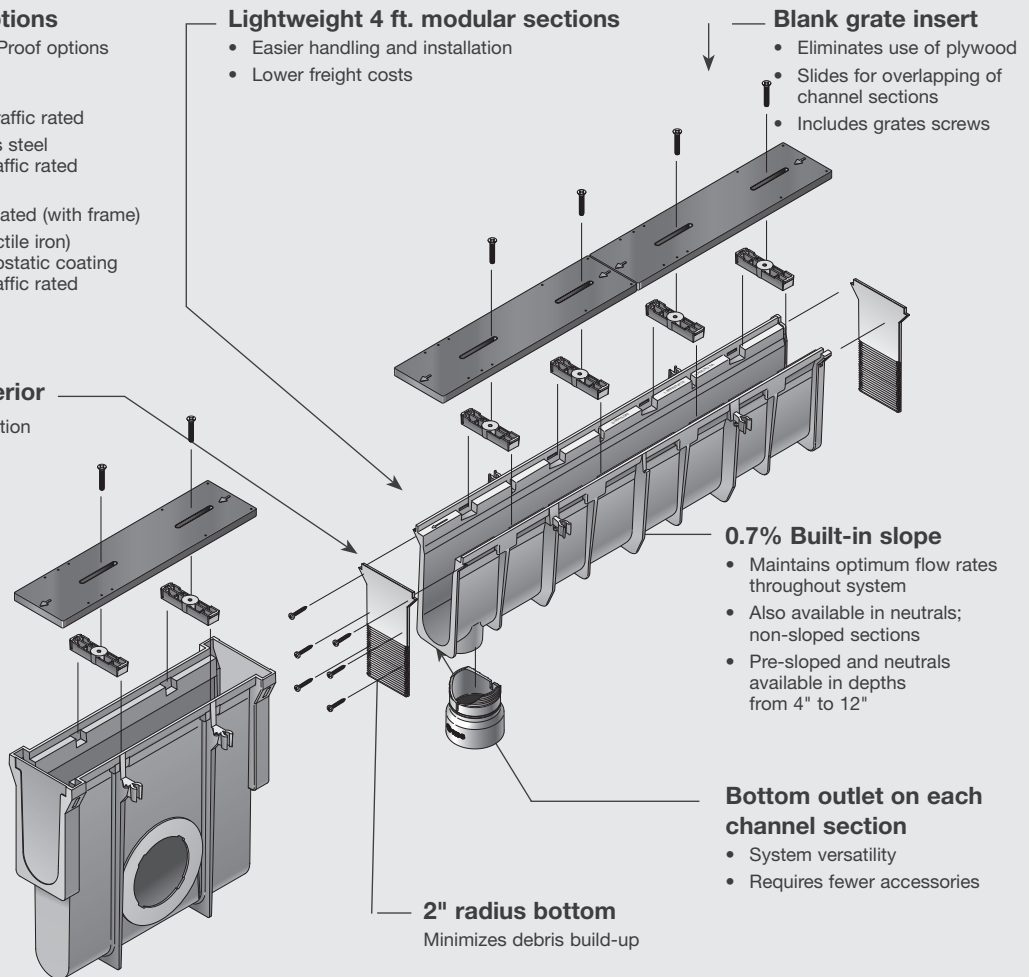

LevelLoc™ re-bar supports with integral protruding knob

- Levels channel and grips re-bar
- Requires fewer accessories

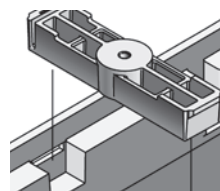

ProFit™ locking system

- Locks grate to integral frame
- Supports product in shipping and installation (included)

DURA SLOPE™ TRENCH DRAIN – PRE-SLOPED

Dura Slope™ Channel Drain Sections and Kits

CHANNEL & TRENCH DRAINS

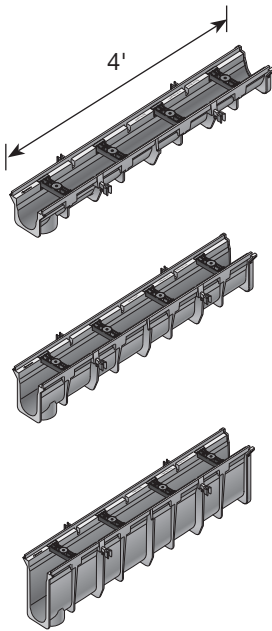

Part No.	Description	Color	Pkg. Qty.	Wt. Ea. (lbs.)	Product Class
DS-090N	3.99" Deep Neutral Dura Slope Channel	Light Gray	1	7.45	25DS
DS-091	3.99" to 4.34" Deep Dura Slope Channel	Light Gray	1	7.52	25DS
DS-091N	4.34" Deep Neutral Dura Slope Channel	Light Gray	1	7.81	25DS
DS-091NDIKIT	4.3" Invert Depth Neutral Channel Drain Kit, Ductile Iron Grates, End Outlet, End Cap	Light Gray	1		25DS
DS-092	4.34" to 4.67" Deep Dura Slope Channel	Light Gray	1	7.92	25DS
DS-093	4.67" to 5.00" Deep Dura Slope Channel	Light Gray	1	8.27	25DS
DS-094	5.00" to 5.34" Deep Dura Slope Channel	Light Gray	1	8.64	25DS
DS-094N	5.34" Deep Neutral Dura Slope Channel	Light Gray	1	8.93	25DS
DS-095	5.34" to 5.68" Deep Dura Slope Channel	Light Gray	1	8.99	25DS
DS-096	5.68" to 6.01" Deep Dura Slope Channel	Light Gray	1	9.36	25DS
DS-097	6.01" to 6.35" Deep Dura Slope Channel	Light Gray	1	9.74	25DS
DS-097N	6.35" Deep Neutral Dura Slope Channel	Light Gray	1	10.04	25DS
DS-098	6.35" to 6.69" Deep Dura Slope Channel	Light Gray	1	10.11	25DS
DS-099	6.69" to 7.02" Deep Dura Slope Channel	Light Gray	1	10.48	25DS
DS-100	7.02" to 7.36" Deep Dura Slope Channel	Light Gray	1	10.86	25DS
DS-100N	7.36" Deep Neutral Dura Slope Channel	Light Gray	1	11.16	25DS
DS-101	7.36" to 7.69" Deep Dura Slope Channel	Light Gray	1	11.23	25DS
DS-102	7.69" to 8.03" Deep Dura Slope Channel	Light Gray	1	11.60	25DS
DS-103	8.03" to 8.37" Deep Dura Slope Channel	Light Gray	1	11.98	25DS
DS-103N	8.37" Deep Neutral Dura Slope Channel	Light Gray	1	12.27	25DS
DS-104	8.37" to 8.70" Deep Dura Slope Channel	Light Gray	1	12.34	25DS
DS-105	8.70" to 9.04" Deep Dura Slope Channel	Light Gray	1	12.71	25DS
DS-106	9.04" to 9.37" Deep Dura Slope Channel	Light Gray	1	13.07	25DS
DS-106N	9.37" Deep Neutral Dura Slope Channel	Light Gray	1	13.39	25DS
DS-107	9.37" to 9.70" Deep Dura Slope Channel	Light Gray	1	13.40	25DS
DS-108	9.70" to 10.05" Deep Dura Slope Channel	Light Gray	1	13.83	25DS
DS-109	10.05" to 10.38" Deep Dura Slope Channel	Light Gray	1	14.20	25DS
DS-109N	10.38" Deep Neutral Dura Slope Channel	Light Gray	1	14.50	25DS
DS-110	10.38" to 10.71" Deep Dura Slope Channel	Light Gray	1	14.57	25DS
DS-111	10.71" to 11.05" Deep Dura Slope Channel	Light Gray	1	14.95	25DS
DS-112	11.05" to 11.39" Deep Dura Slope Channel	Light Gray	1	15.32	25DS
DS-112N	11.39" Deep Neutral Dura Slope Channel	Light Gray	1	15.60	25DS
DS-113	11.39" to 11.72" Deep Dura Slope Channel	Light Gray	1	15.69	25DS
DS-114	11.72" to 12.06" Deep Dura Slope Channel	Light Gray	1	16.06	25DS

DURA SLOPE™ TRENCH DRAIN – PRE-SLOPED

Standard Grates

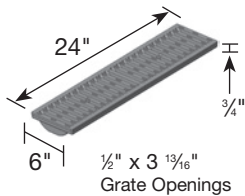

Part No.	Description	Color	Pkg. Qty.	Wt. Ea. (lbs.)	Product Class	Specifications
660	2 ft. Channel Grate	White	1	2.82	25DS	2 ft. Structural Foam Polyolefin, secured Channel Grate with UV inhibitor. Open surface area 25.40 square inches per foot. 77.70 GPM per foot.
661	2 ft. Channel Grate	Dark Gray	1	2.82	25DS	
661LG	2 ft. Channel Grate	Light Gray	1	2.82	25DS	
662	2 ft. Channel Grate	Green	1	2.82	25DS	
663	2 ft. Channel Grate	Black	1	2.82	25DS	
664	2 ft. Channel Grate	Sand	1	2.82	25DS	
665	2 ft. Channel Grate	Brick Red	1	2.82	25DS	
 Use with Dura Slope Drains (page 72), Dura Slope Catch Basins (page 74). (see page 79). ADA Compliant.						

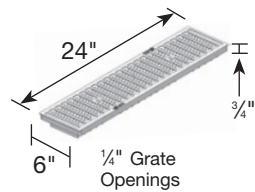

Part No.	Description	Color	Pkg. Qty.	Wt. Ea. (lbs.)	Product Class	Specifications
DS-670	2 ft. Plastic Perforated Channel Grate	Light Gray	1	2.81	25DS	2 ft. Structural Foam Polyolefin, secured Channel Grate with UV inhibitor, light traffic rated, heelproof, ADA compliant. Open surface area 8.75 square inches per foot. 26.77 GPM per foot.
DS-671	2 ft. Plastic Perforated Channel Grate	White	1	2.81	25DS	
 Use with Dura Slope Drains (page 72), Dura Slope Catch Basins (page 74). (see page 79). ADA Compliant/Heelproof.						

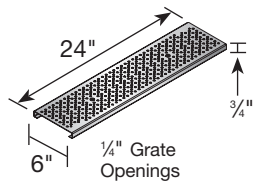

Part No.	Description	Color	Pkg. Qty.	Wt. Ea. (lbs.)	Product Class	Specifications
DS-226	2 ft. Stainless Steel Perforated Channel Grate	Steel	1	3.16	25DS	Perforated Metal Grate, pedestrian traffic rated, heelproof, ADA compliant. Open surface area 7.63 square inches per foot. 23.34 GPM per foot.
DS-228	2 ft. Galvanized Steel Perforated Channel Grate	Steel	1	3.83	25DS	
 Use with Dura Slope Drains (page 72), Dura Slope Catch Basins (page 74). (see page 79). ADA Compliant/Heelproof.						

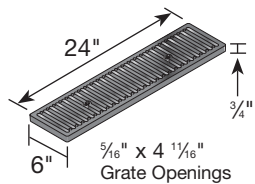

Part No.	Description	Color	Pkg. Qty.	Wt. Ea. (lbs.)	Product Class	Specifications
DS-231	2 ft. Cast Iron Channel Grate	Black	1	18.90	25DS	2 ft. heavy-duty Iron Channel Grate. Open surface area 20.85 square inches per foot. 63.78 GPM per foot. H-20 load rating.
DS-232	2 ft. Ductile Iron	Black	1	15.20	25DS	
 Use with Dura Slope Drains (page 72), Dura Slope Catch Basins (page 74). (see page 79). ADA Compliant. Must be used with DS-200H to achieve Class D Load Rating.						

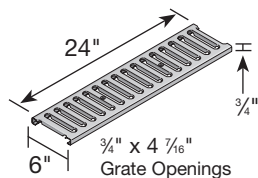

Part No.	Description	Color	Pkg. Qty.	Wt. Ea. (lbs.)	Product Class	Specifications
DS-221	2 ft. Galvanized Steel Channel Grate	Steel	1	6.64	25DS	2 ft. Galvanized Rolled Steel Grate. Open surface area 23.09 square inches per foot. 70.64 GPM per foot.
 Use with Dura Slope Drains (page 72), Dura Slope Catch Basins (page 74). Includes bracket to attach grate to channel and screws. (see page 79)						

DURA SLOPE™ TRENCH DRAIN – PRE-SLOPED

Slot Top



Part No.	Description	Color	Pkg. Qty.	Wt. Ea. (lbs.)	Product Class
DS-ST4	4 ft. Slot Top with Galvanized Steel Grate	Galvanized Steel	1	17.53	25DS
DS-ST2	2 ft. Slot Top with Galvanized Steel Grate	Galvanized Steel	1	8.86	25DS
DS-STMAINT	2 ft. Slot Top Maintenance Unit	Galvanized Steel	1	14.86	25DS
DS-SS-ST1000	48 in. Slot Top, Asymmetric, Stainless Steel, NW 113, C 250KN, SW 15, 1218/151/133, SH 110	Stainless Steel	1	17.13	25DS
DS-SS-ST500	24 in. Slot Top, Asymmetric, Stainless Steel, NW 113, C 250KN, SW 15, 609/151/133, SH 110	Stainless Steel	1	8.86	25DS
DS-SS-STMAINT	24 in. Maintenance Unit Stainless Steel, NW 113, Asymmetric, SW 15 cl. C 250 KN	Stainless Steel	1	14.86	25DS
13399	Opening Tool for Maintenance Unit (order 2)	N/A	1	0.02	25FC

Decorative Grates

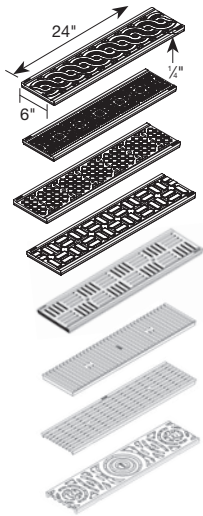

Part No.	Description	Color	Pkg. Qty.	Wt. Ea. (lbs.)	Product Class	Specifications
DS-601	Weave Pattern	Raw Iron	1	11.70	25DS	Decorative grates are made of ductile iron. Weave: open area 7.92 square inches per foot; 24.3 GPM. Diamond: open area 9.25 square inches per foot; 28.3 GPM. Tile: open area 11.93 square inches per foot; 33.6 GPM. Brick: open area 9.72 square inches per foot; 29.8 GPM. Deco slot: open area 17.46 square inches per foot; 53.5 GPM.
DS-602	Diamond Pattern	Raw Iron	1	14.30	25DS	
DS-603	Tile Pattern	Raw Iron	1	14.70	25DS	
DS-604	Brick Pattern	Raw Iron	1	14.30	25DS	
DS-609	Deco Slot	Raw Iron	1	11.70	25DS	
DS-610-KIARO	Kiaro Slot	Ductile Iron	1	14.99	25DS	
DS-611-VIA	Via Slot	Ductile Iron	1	10.36	25DS	
DS-612-VILLE	Ville Pattern	Ductile Iron	1	11.68	25DS	
 Use with Dura Slope Drains (page 72), Dura Slope Catch Basins (see below). Decorative grates are made of ductile iron. Uncoated raw iron will develop a rust patina over time. (see page 79). ADA Compliant/Heel-proof. Must be used with DS-200H to achieve Class D Load Rating.						

In-Line Catch Basin

The NDS Dura Slope™ in-line catch basin is designed to fit all depth ranges of the Dura Slope™ trench drain sections. Catch basin inlets are designed to be sized as required to accept the Dura Slope™ trench drain section. The Dura Slope™ catch basin is 2 feet long and 2 feet deep with an outlet on both sides of the basin. One Universal Adapter Plug, one blank grate insert and two grate screws are included with each Dura Slope™ in-line catch basin. The NDS universal basin outlets are used to adapt the catch basin to 3", 4", 6" and 8" pipe.

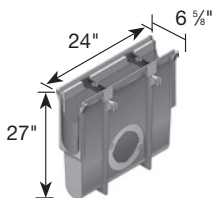

Part No.	Description	Color	Pkg. Qty.	Wt. Ea. (lbs.)	Product Class
DS-340	Dura Slope™ In-Line Catch Basins	Light Gray	1	12.00	25DS
Available for use of one or two outlets. Use #1242, #1243, #1245, #1266, #1206 or #1888 Universal Outlets (see page 35).					

DURA SLOPE™ TRENCH DRAIN – PRE-SLOPED

Trash Bucket

Dura Slope™ Trash Bucket is made to fit inside the Dura Slope™ Catch Basin (part number DS-340). It has a handle for easy removal to clean leaves and debris; it requires removal of the grate. Made of zinc plated steel, it is durable to climatic conditions. The Trash Bucket is not intended for use with any of the Dura Slope™ Channels. *Note: DS-240 Trash Bucket is not for use with the DS-200H Ductile Iron Frame.*

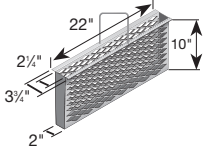

Part No.	Description	Color	Pkg. Qty.	Wt. Ea. (lbs.)	Product Class
DS-240	Dura Slope™ Trash Bucket	Steel Zinc-Plated Steel	1	5.00	25DS

Accessories

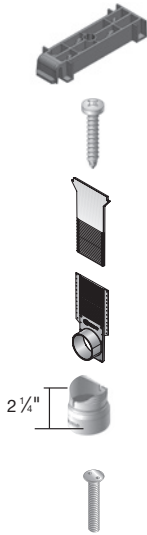

Part No.	Description	Color	Pkg. Qty.	Wt. Ea. (lbs.)	Product Class
DS-122	ProFit™ Grate Lock	Black	8	0.80	25DS
DS-123	Dura Slope Frame & End Cap Screws PH. #6 Use on DS-229 Universal End Cap & DS-227 x 3/4". Universal End Outlet downstream for (male) end. Use to attach DS-200 DI Frame to Channel.	Stainless Steel	12		25DS
DS-224	Universal End Cap Replaces DS-124, which will not work with DS-113 or deeper channels. Slides into upstream (female) end. Requires DS-123 screws on downstream (male) end.	Gray	8	0.63	25DS
DS-227	Universal End Outlet Replaces DS-127, which will not work with DS-113 or deeper channels. Requires DS-123 screws for use on downstream (male) end. Fits to 4" S&D Pipe.	Gray	6	0.75	25DS
DS-126	Bottom Outlet Adapter Fits to 4" S&D Pipe. DS-126 not required for Sch. 40 connection.	Gray	6	0.53	25DS
629	Grate Screws FH # 1/4 – 20 x 1-1/2" 2 Needed per Grate. Use with Grate # DS-231, DS-232, DS-670, DS-226 and 660-665. Use to secure grates in applications without DS-200 DI Frame	Stainless Steel	40	0.70	25PF
DS-650	Flat Drilled Spanner End Cap Screws #6, 3/4" Drill bit included with each package.	Stainless Steel	12	1	25DS

Ductile Iron Frame

Dura Slope Ductile Iron Frame provides a Class D load rating of 326-575 psi and is suitable for heavy-duty hard tire equipment at speeds less than 20 mph. The DS-200H Ductile Iron Frame is recommended for use with pneumatic tire traffic such as fork lifts. The ductile iron frame can be used with the cast and ductile iron grates. *Note: DS-123 screws must be ordered to secure frame to the channel.*

Part No.	Description	Color	Pkg. Qty.	Wt. Ea. (lbs.)	Product Class
DS-200H	Dura Slope™ Ductile Iron Frame  Use with Dura Slope Drains (page 72), Dura Slope Catch Basins (page 74). To be used with DS-231 or DS-232 grates. New Feature: 1/4" Brass Nuts to secure channel inserted. (see page 79). ADA Compliant/Heel-proof when used with DS-231 or DS-232 grates.	Black	2 ft.	7.50	25DS

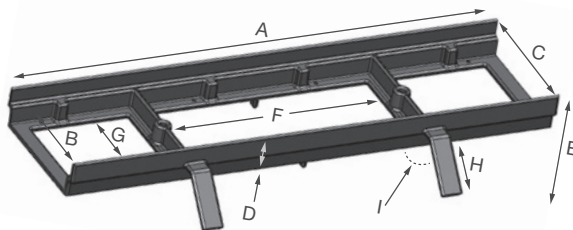

Dimension Key		
A	Length	24"
B	Inner Width	6"
C	Outer Width	6-3/8"
D	Added Profile	1" Height
E	Total Height	2-3/4"
F	Opening Length	10-3/4"
G	Opening Width	4-1/2"
H	Length of Anchor	2-5/8"
I	Angle of Anchor	30°

DURA SLOPE™ TRENCH DRAIN – PRE-SLOPED

Radius Coupling & Grates

Patent Pending

CHANNEL & TRENCH DRAINS

Designed specifically for draining 400-meter running tracks, Dura Slope™ Radius Couplings allow 3 degrees of deflection between trench drain sections, making an adjustable radius easily achievable for standard tracks and other curving applications.



Details

- 80'-120' radius
- Heavy-duty HDPE trench drain
- No Special tools required components snap into place
- Four depths available
- Grate options: standard & slotted
- Flexible radius coupling (patent pending)

Radius Coupling

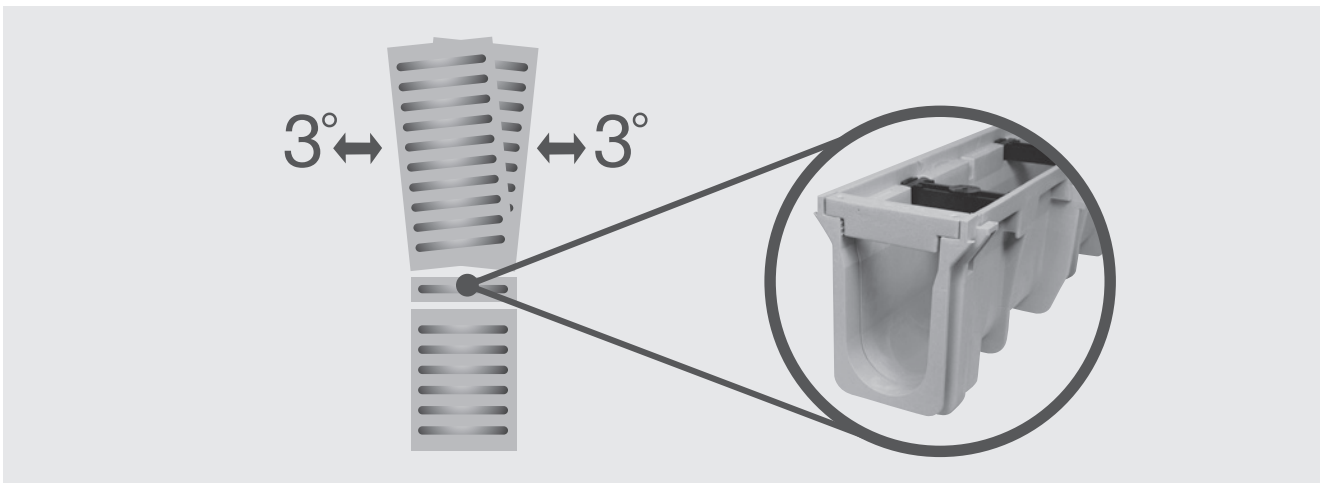

DURA SLOPE™ TRENCH DRAIN – PRE-SLOPED

EZ-Track™ Radius Coupling & Grates



Part No.	Description	Color	Pkg. Qty.	Wt. Ea. (lbs.)	Product Class	Specifications
DSRC-097	6.35" Deep Neutral Dura Slope™ Radius Coupling	Light Gray	6	0.81	25DS	3 degree max. deflection per coupling. Minimum inside radius of 26".
DSRC-100	7.36" Deep Neutral Dura Slope™ Radius Coupling	Light Gray	6	0.82	25DS	
DSRC-103	8.37" Deep Neutral Dura Slope™ Radius Coupling	Light Gray	6	0.83	25DS	
DSRC-106	9.37" Deep Neutral Dura Slope™ Radius Coupling	Light Gray	6	0.84	25DS	
DSRC	Dura Slope™ Radius Coupling	Light Gray	6	0.86	25DS	



Part No.	Description	Color	Pkg. Qty.	Wt. Ea. (lbs.)	Product Class	Specifications
DS-660MG	1.25" Plastic Slotted Radius Coupling Grate	White	6	0.15	25DS	Structural Foam Polyolefin Radius Coupling Channel Grate with UV inhibitor. Open surface area 1.88 square inches per grate. 5.75 GPM per grate.
DS-661MG	1.25" Plastic Slotted Radius Coupling Grate	Dark Gray	6	0.15	25DS	
DS-661LGMG	1.25" Plastic Slotted Radius Coupling Grate	Light Gray	6	0.15	25DS	
DS-662MG	1.25" Plastic Slotted Radius Coupling Grate	Green	6	0.15	25DS	
DS-663MG	1.25" Plastic Slotted Radius Coupling Grate	Black	6	0.15	25DS	
DS-664MG	1.25" Plastic Slotted Radius Coupling Grate	Sand	6	0.15	25DS	
DS-665MG	1.25" Plastic Slotted Radius Coupling Grate	Brick Red	6	0.15	25DS	



Part No.	Description	Color	Pkg. Qty.	Wt. Ea. (lbs.)	Product Class	Specifications
DS-681LGMG	1.25" Plastic Standard Radius Coupling Grate (no slot)	Light Gray	6	0.16	25DS	Solid Structural Foam Polyolefin Radius Coupling Channel Grate with UV inhibitor.

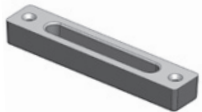

Part No.	Description	Color	Pkg. Qty.	Wt. Ea. (lbs.)	Product Class	Specifications
DS-232MG	1.25" Ductile Iron Radius Coupling Grate	Black	6	0.93	25DS	Ductile Iron Radius Coupling Channel Grate. Open surface area 1.88 square inches per grate. 5.75 GPM per grate.



Part No.	Description	Color	Pkg. Qty.	Wt. Ea. (lbs.)	Product Class	Specifications
DS-226MG	1.25" Perforated Stainless Steel Radius Coupling Grate	Steel	6	0.25	25DS	Stainless Steel Radius Coupling Channel Grate. Open surface area 0.86 square inches per grate. 2.63 GPM per grate.



Part No.	Description	Color	Pkg. Qty.	Wt. Ea. (lbs.)	Product Class	Specifications
DS-221MG	1.25" Galvanized Steel Radius Coupling Grate	Steel	6	0.33	25DS	Galvanized Steel Radius Coupling Channel Grate. Open surface area 1.31 square inches per grate. 4.01 GPM per grate.

DURA SLOPE™ TRENCH DRAIN – PRE-SLOPED

Dura Slope™ System Profiles

CHANNEL & TRENCH DRAINS

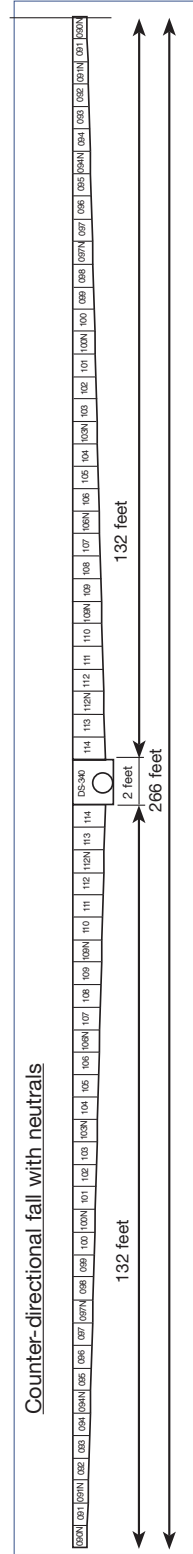
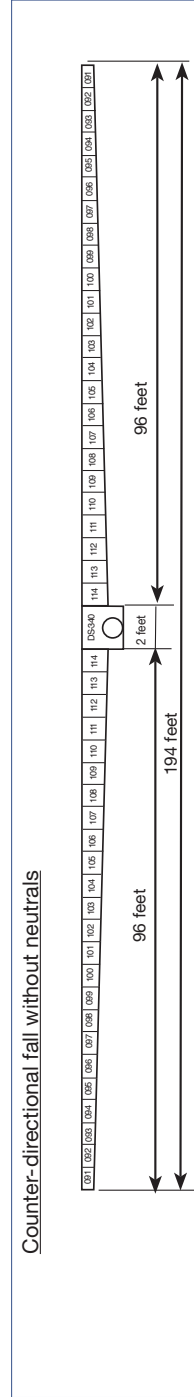
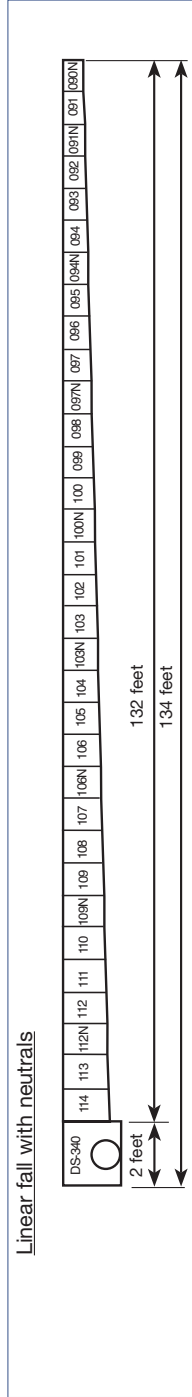
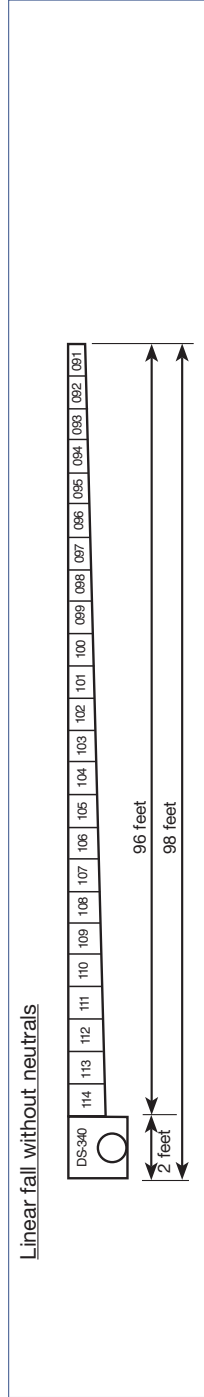
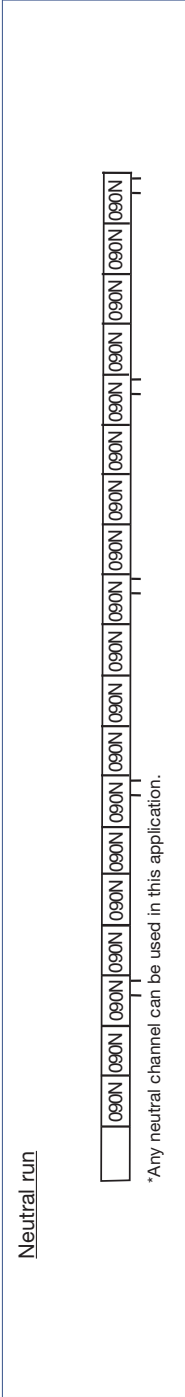

Note: Drawings are not to scale. See previous pages for actual product dimensions.

LOAD RECOMMENDATION GUIDE

NDS Class A

- Loads of 1-60 psi.
- Recommended for pedestrians, bicycles and wheelchair traffic.



NDS Class B

- Loads of 61-175 psi.
- Recommended for medium-duty pneumatic tire traffic, autos and light trucks at speeds less than 20 m.p.h.



NDS Class C

- Loads of 176-325 psi.
- Recommended for heavy-duty pneumatic tire forklifts and tractor-trailers at speeds less than 20 m.p.h., H-20 rated.



NDS Class D

- Loads of 326-575 psi.
- Recommended for heavy-duty hard tire forklifts at speeds less than 20 m.p.h., H-20 rated.



Notes: Some installations may require a concrete collar to meet load rating. Load ratings are based on encasing product in concrete. Product must be installed using NDS instructions.

Cast iron grates will oxidize over time and rust, forming an iron-oxide patina. The iron-oxide layer begins red-orange in color and ages to a deep, rich brown. This patina is tightly adhered and protects the iron beneath it from further oxidation. Iron grates with a rust patina are structurally sound and will last for decades.

Visit [ndspro.com](https://www.ndspro.com) for complete installation specifications, guidelines & details.

BG-FILCOTEN®

A Heavyweight When it Comes to Features

BG-FILCOTEN® combines smart engineering and smart materials to provide a superior trench drain suitable for handling a high load capacity. Combining the features of a stable concrete channel with the strength, durability and environmental-friendliness of fiber-reinforced concrete, BG-FILCOTEN® is the ideal choice for a wide variety of sites and applications.

Applications

Because BG-FILCOTEN® can handle a high load capacity, it is especially suitable for installation in industrial areas such as factories, garages and parking lots. With its sleek design it can easily be used in public places like railway stations, and pedestrian or residential areas. reinforced concrete, BG-FILCOTEN® is the ideal choice for a wide variety of sites and applications.

Product Features & Benefits

- Temperature, frost and UV resistant. Less contraction and expansion and longer product life.
- 100% recyclable/0% harmful substances. Sustainable solution without VOCs or heavy-metal residue that can leach into the ground. Qualifies for LEED credits.
- Non-flammable. Manufactured without resins, BG-FILCOTEN® is rated A1, non-combustible.
- Monolithic adhesion. Free from de-molding agents, BG-FILCOTEN® bonds securely with the surrounding concrete.

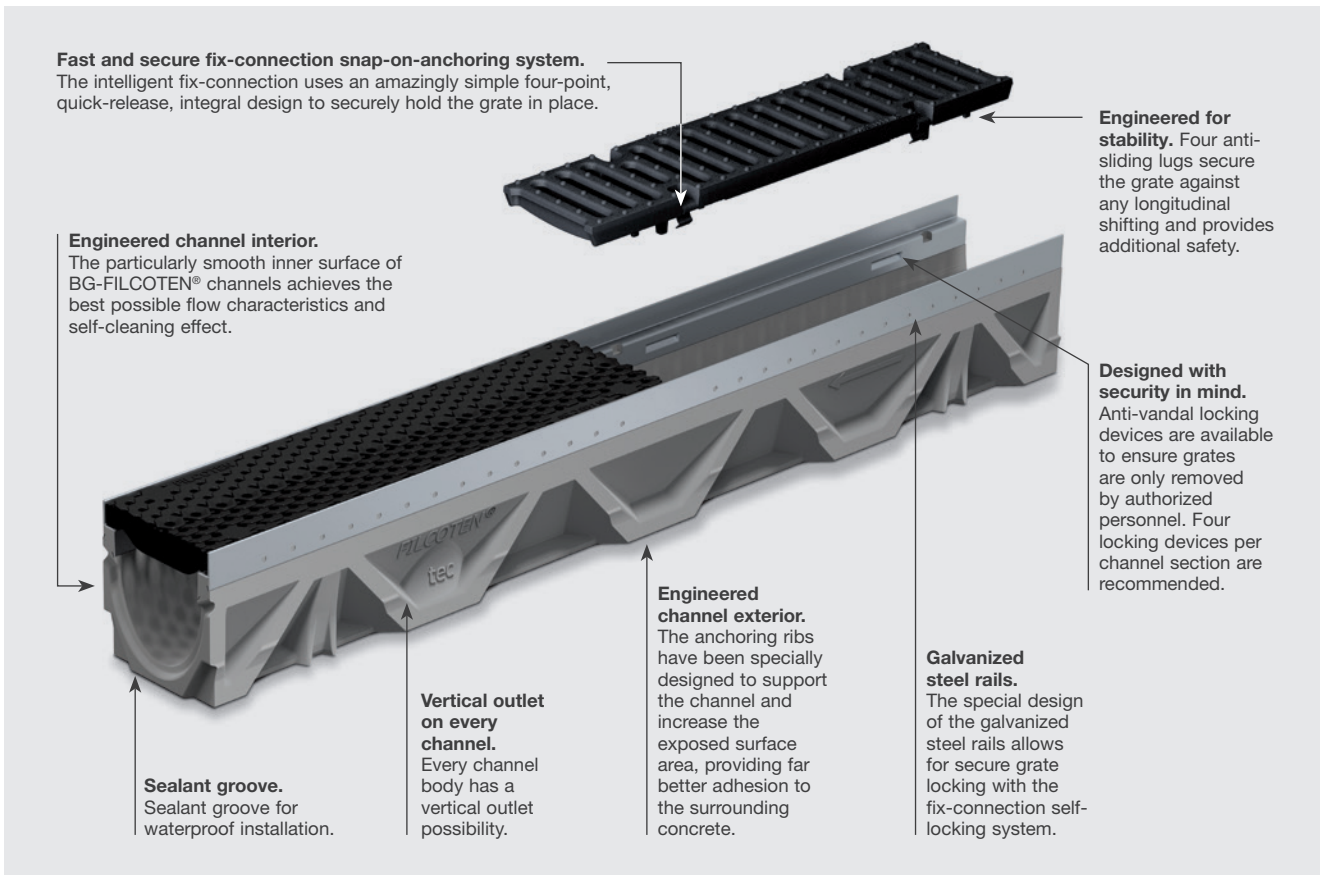

BG-FILCOTEN®

4" BG-FILCOTEN TEC V 100 Trench Drain

Tech V 100 Galvanized Steel Trench Drain

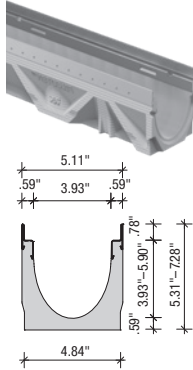

Part No.	Description	Material	Carton Qty.	Weight Ea. (lbs.)	Length Ea. (in.)	Product Class
10410200	BG-FILCOTEN Tec V 100 Channel 0 without slope	Galvanized Rail	1	28.88	39.37	25FC
10410201	BG-FILCOTEN Tec V 100 Channel 1 with .5% slope	Galvanized Rail	1	29.32	39.37	25FC
10410202	BG-FILCOTEN Tec V 100 Channel 2 with .5% slope	Galvanized Rail	1	30.20	39.37	25FC
10410203	BG-FILCOTEN Tec V 100 Channel 3 with .5% slope	Galvanized Rail	1	30.86	39.37	25FC
10410204	BG-FILCOTEN Tec V 100 Channel 4 with .5% slope	Galvanized Rail	1	31.75	39.37	25FC
10410205	BG-FILCOTEN Tec V 100 Channel 5 with .5% slope	Galvanized Rail	1	32.63	39.37	25FC
10410206	BG-FILCOTEN Tec V 100 Channel 6 with .5% slope	Galvanized Rail	1	33.51	39.37	25FC
10410207	BG-FILCOTEN Tec V 100 Channel 7 with .5% slope	Galvanized Rail	1	34.29	39.37	25FC
10410208	BG-FILCOTEN Tec V 100 Channel 8 with .5% slope	Galvanized Rail	1	35.05	39.37	25FC
10410209	BG-FILCOTEN Tec V 100 Channel 9 with .5% slope	Galvanized Rail	1	35.94	39.37	25FC
10410210	BG-FILCOTEN Tec V 100 Channel 10 with .5% slope	Galvanized Rail	1	36.82	39.37	25FC
10410261	BG-FILCOTEN Tec V 100 Channel 5-0 without slope	Galvanized Rail	1	33.07	39.37	25FC
10410262	BG-FILCOTEN Tec V 100 Channel 10-0 without slope	Galvanized Rail	1	37.26	39.37	25FC
10410211	BG-FILCOTEN Tec V 100 Channel 11 with .5% slope	Galvanized Rail	1	29.54	39.37	25FC
10410212	BG-FILCOTEN Tec V 100 Channel 12 with .5% slope	Galvanized Rail	1	31.09	39.37	25FC
10410213	BG-FILCOTEN Tec V 100 Channel 13 with .5% slope	Galvanized Rail	1	32.63	39.37	25FC
10410214	BG-FILCOTEN Tec V 100 Channel 14 with .5% slope	Galvanized Rail	1	33.95	39.37	25FC
10410215	BG-FILCOTEN Tec V 100 Channel 15 with .5% slope	Galvanized Rail	1	35.05	39.37	25FC
10410216	BG-FILCOTEN Tec V 100 Channel 16 with .5% slope	Galvanized Rail	1	36.16	39.37	25FC
10410217	BG-FILCOTEN Tec V 100 Channel 17 with .5% slope	Galvanized Rail	1	37.04	39.37	25FC
10410218	BG-FILCOTEN Tec V 100 Channel 18 with .5% slope	Galvanized Rail	1	38.36	39.37	25FC
10410219	BG-FILCOTEN Tec V 100 Channel 19 with .5% slope	Galvanized Rail	1	39.68	39.37	25FC
10410220	BG-FILCOTEN Tec V 100 Channel 20 with .5% slope	Galvanized Rail	1	40.79	39.37	25FC
10410264	BG-FILCOTEN Tec V 100 Channel 20-0 without slope	Galvanized Rail	1	41.23	39.37	25FC

MTO: 6-7 week lead time

CHANNEL & TRENCH DRAINS

BG-FILCOTEN®

8" BG-FILCOTEN PRO V 200 Trench Drain

Pro 200 Galvanized Steel Trench Drain

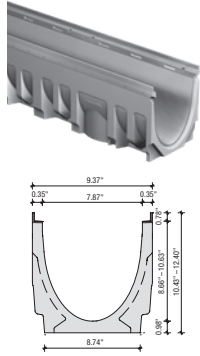

Part No.	Description	Material	Carton Qty.	Weight Ea. (lbs.)	Length Ea. (in.)	Product Class
10620200	BG-FILCOTEN Pro V 200 Channel 0 without slope	Galvanized Rail	1	97.00	39.37	25FC
10620201	BG-FILCOTEN Pro V 200 Channel 1 with .5% slope	Galvanized Rail	1	98.11	39.37	25FC
10620202	BG-FILCOTEN Pro V 200 Channel 2 with .5% slope	Galvanized Rail	1	100.31	39.37	25FC
10620203	BG-FILCOTEN Pro V 200 Channel 3 with .5% slope	Galvanized Rail	1	102.51	39.37	25FC
10620204	BG-FILCOTEN Pro V 200 Channel 4 with .5% slope	Galvanized Rail	1	104.72	39.37	25FC
10620205	BG-FILCOTEN Pro V 200 Channel 5 with .5% slope	Galvanized Rail	1	106.92	39.37	25FC
10620206	BG-FILCOTEN Pro V 200 Channel 6 with .5% slope	Galvanized Rail	1	109.13	39.37	25FC
10620207	BG-FILCOTEN Pro V 200 Channel 7 with .5% slope	Galvanized Rail	1	111.33	39.37	25FC
10620208	BG-FILCOTEN Pro V 200 Channel 8 with .5% slope	Galvanized Rail	1	113.54	39.37	25FC
10620209	BG-FILCOTEN Pro V 200 Channel 9 with .5% slope	Galvanized Rail	1	115.74	39.37	25FC
10620210	BG-FILCOTEN Pro V 200 Channel 10 with .5% slope	Galvanized Rail	1	117.95	39.37	25FC
10620261	BG-FILCOTEN Pro V 200 Channel 5-0 without slope	Galvanized Rail	1	108.30	39.37	25FC
10620262	BG-FILCOTEN Pro V 200 Channel 10-0 without slope	Galvanized Rail	1	118.83	39.37	25FC
10620264	BG-FILCOTEN Pro V 200 Channel 20-0 without slope	Galvanized Rail	1	138.23	39.37	25FC
10620211	BG-FILCOTEN Pro V 200 Channel 11 with .5% slope	Galvanized Rail	1	199.42	39.37	25FC
10620212	BG-FILCOTEN Pro V 200 Channel 12 with .5% slope	Galvanized Rail	1	203.51	39.37	25FC
10620213	BG-FILCOTEN Pro V 200 Channel 13 with .5% slope	Galvanized Rail	1	207.59	39.37	25FC
10620214	BG-FILCOTEN Pro V 200 Channel 14 with .5% slope	Galvanized Rail	1	211.68	39.37	25FC
10620215	BG-FILCOTEN Pro V 200 Channel 15 with .5% slope	Galvanized Rail	1	215.77	39.37	25FC
10620216	BG-FILCOTEN Pro V 200 Channel 16 with .5% slope	Galvanized Rail	1	219.86	39.37	25FC
10620217	BG-FILCOTEN Pro V 200 Channel 17 with .5% slope	Galvanized Rail	1	223.95	39.37	25FC
10620218	BG-FILCOTEN Pro V 200 Channel 18 with .5% slope	Galvanized Rail	1	228.03	39.37	25FC
10620219	BG-FILCOTEN Pro V 200 Channel 19 with .5% slope	Galvanized Rail	1	232.12	39.37	25FC
10620220	BG-FILCOTEN Pro V 200 Channel 20 with .5% slope	Galvanized Rail	1	236.21	39.37	25FC
10620290	BG-FILCOTEN Pro V 200 Sump	Galvanized Rail	1	105.82	19.69	25FC

12" BG-FILCOTEN PRO V 300 Trench Drain

Pro V 300 Galvanized Steel Trench Drain

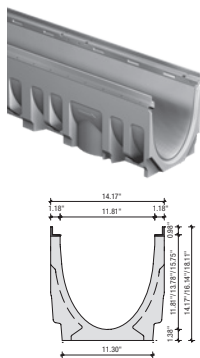

Part No.	Description	Material	Carton Qty.	Weight Ea. (lbs.)	Length Ea. (in.)	Product Class
10630201	BG-FILCOTEN Pro V 300 Channel 1 with .5" slope	Galvanized Rail	1	168.21	39.37	25FC
10630202	BG-FILCOTEN Pro V 300 Channel 2 with .5" slope	Galvanized Rail	1	171.08	39.37	25FC
10630203	BG-FILCOTEN Pro V 300 Channel 3 with .5" slope	Galvanized Rail	1	173.94	39.37	25FC
10630204	BG-FILCOTEN Pro V 300 Channel 4 with .5" slope	Galvanized Rail	1	176.81	39.37	25FC
10630205	BG-FILCOTEN Pro V 300 Channel 5 with .5" slope	Galvanized Rail	1	179.67	39.37	25FC
10630206	BG-FILCOTEN Pro V 300 Channel 6 with .5" slope	Galvanized Rail	1	182.54	39.37	25FC
10630207	BG-FILCOTEN Pro V 300 Channel 7 with .5" slope	Galvanized Rail	1	185.41	39.37	25FC
10630208	BG-FILCOTEN Pro V 300 Channel 8 with .5" slope	Galvanized Rail	1	188.27	39.37	25FC
10630209	BG-FILCOTEN Pro V 300 Channel 9 with .5" slope	Galvanized Rail	1	191.14	39.37	25FC
10630210	BG-FILCOTEN Pro V 300 Channel 10 with .5" slope	Galvanized Rail	1	194.00	39.37	25FC
10630200	BG-FILCOTEN Pro V 300 Channel 0 without slope	Galvanized Rail	1	166.67	39.37	25FC
10630261	BG-FILCOTEN Pro V 300 Channel 5-0 without slope	Galvanized Rail	1	181.00	39.37	25FC
10630262	BG-FILCOTEN Pro V 300 Channel 10-0 without slope	Galvanized Rail	1	195.33	39.37	25FC
10630264	BG-FILCOTEN Pro V 300 Channel 20-0 without slope	Galvanized Rail	1	240.30	39.37	25FC
10630211	BG-FILCOTEN Pro V 300 Channel 11 with .5% slope	Galvanized Rail	1	199.42	39.37	25FC
10630212	BG-FILCOTEN Pro V 300 Channel 12 with .5% slope	Galvanized Rail	1	203.51	39.37	25FC
10630213	BG-FILCOTEN Pro V 300 Channel 13 with .5% slope	Galvanized Rail	1	207.59	39.37	25FC
10630214	BG-FILCOTEN Pro V 300 Channel 14 with .5% slope	Galvanized Rail	1	211.68	39.37	25FC
10630215	BG-FILCOTEN Pro V 300 Channel 15 with .5% slope	Galvanized Rail	1	215.77	39.37	25FC
10630216	BG-FILCOTEN Pro V 300 Channel 16 with .5% slope	Galvanized Rail	1	219.86	39.37	25FC
10630217	BG-FILCOTEN Pro V 300 Channel 17 with .5% slope	Galvanized Rail	1	223.95	39.37	25FC
10630218	BG-FILCOTEN Pro V 300 Channel 18 with .5% slope	Galvanized Rail	1	228.03	39.37	25FC
10630219	BG-FILCOTEN Pro V 300 Channel 19 with .5% slope	Galvanized Rail	1	232.12	39.37	25FC
10630220	BG-FILCOTEN Pro V 300 Channel 20 with .5% slope	Galvanized Rail	1	236.21	39.37	25FC
10630290	BG-FILCOTEN Crate Basin	Galvanized Rail	1	273.37		25FC

BG-FILCOTEN®

BG-FILCOTEN TEC V 100 Grates (4")

CHANNEL & TRENCH DRAINS

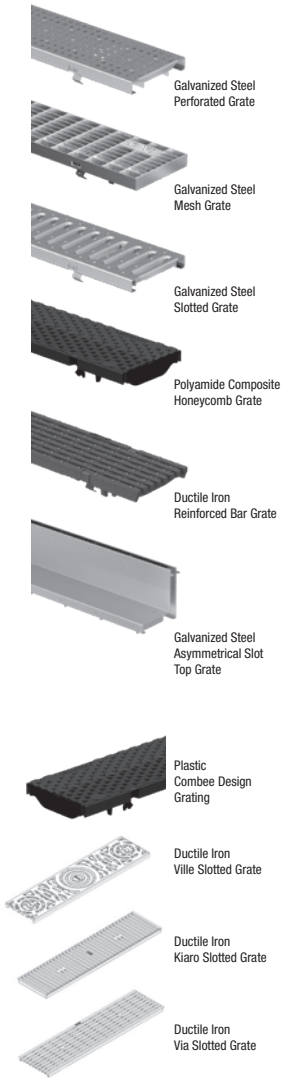

Part No.	Description	Material	Carton Qty.	Weight Ea. (lbs.)	Length Ea. (in.)	Product Class
17010105	BG-FILCOTEN 100 DI Slotted Grate Class E 19.69 in	Ductile Iron	1	8.38	19.69	25FC
17010106	BG-FILCOTEN 100 DI Bar Grate ADA/Heelproof Class C 19.69 in	Ductile Iron	1	7.94	19.69	25FC
17010110	BG-FILCOTEN 100 DI Bar Grate Class D 19.69 in	Ductile Iron	1	7.50	19.69	25FC
17010202	BG-FILCOTEN 100 G Slotted Grate Class A 39.37 in	Galvanized Steel	1	3.31	39.37	25FC
17010203	BG-FILCOTEN 100 G Slotted Grate Class A 19.69 in	Galvanized Steel	1	1.76	19.69	25FC
17010204	BG-FILCOTEN 100 G Perforated Grate Class A 39.37 in	Galvanized Steel	1	4.19	39.37	25FC
17010205	BG-FILCOTEN 100 G Perforated Grate Class A 19.69 in	Galvanized Steel	1	2.20	19.69	25FC
17010206	BG-FILCOTEN 100 G Slotted Grate Class C 39.37 in	Galvanized Steel	1	9.92	39.37	25FC
17010207	BG-FILCOTEN 100 G Slotted Grate Class C 19.69 in	Galvanized Steel	1	4.85	19.69	25FC
17010220	BG-FILCOTEN 100 G Mesh Grate Class B 39.37 in	Galvanized Steel	1	6.17	39.37	25FC
17010221	BG-FILCOTEN 100 G Mesh Grate Class B 19.69 in	Galvanized Steel	1	3.09	19.69	25FC
17010228	BG-FILCOTEN 100 G Perforated Grate Class C 39.37 in	Galvanized Steel	1	7.28	39.37	25FC
17010229	BG-FILCOTEN 100 G Perforated Grate Class C 19.69 in	Galvanized Steel	1	3.75	19.69	25FC
17010402	BG-FILCOTEN 100 P Honeycomb Grate Class C 19.69 in	Plastic	1	2.43	19.69	25FC
17010401	Combee Design Grating (Plastic) NW 100, 500/123/20, Class B 125 KN, With Fix-Locking-System	Plastic	1	2.43	19.69	25DS
17010111	Ductile Iron Design Grate "Ville" NW 100, 500/122/25, Class E 600 KN (Tec, Pro)", Slot Width Maximum 8Mm	Ductile Iron	1	11.46	19.69	25DS
17010183	Ductile Iron Design Grate "Kiario" NW 100, 500/122/20, Class D 400 KN (Tec, Pro), Slot/Mesh Width 100X5.7mm	Ductile Iron	1	9.48	19.69	25DS
17010184	Ductile Iron Design Grate "Via" NW 100, 500/122/20, Class D 400 KN (Tec, Pro), Slot/Mesh Width 29X6mm	Ductile Iron	1	9.25	19.69	25DS
171114	Slot Top Galvanized Steel NW100, asymmetric, SW 2 X 6 Mm, Class C 250 KN, 1000/123/133 Sh 110	Galvanized Steel	1	11.8	19.69	25FC
171115	Slot Top Galvanized Steel NW100, asymmetric, SW 2 x 6 mm, Class C 250 KN, 500/123/133 SH 110	Galvanized Steel	1	5.98	19.69	25FC
17111304	Slot Top Stainless Steel NW100, asymmetric, SW 2 x 6 mm, Class C 250 KN, 1000/123/133 SH 110	Stainless Steel	1	11.8	19.69	25FC
17111305	Slot Top Stainless Steel NW100, asymmetric, SW 2 x 6 mm, Class C 250 KN, 500/123/133 SH 110	Stainless Steel	1	5.98	19.69	25FC
171116	Maintenance unit Slot Top Galvanized Steel NW100, asymmetric, SW 2 x 6 mm, cl. C 250 KN	Galvanized Steel	1	11.02		25FC
17111306	Maintenance unit Slot Top Stainless Steel NW100, asymmetric, SW 2 x 6 mm, cl. C 250 KN	Stainless Steel	1	11.02		25FC

See load recommendation guide page 87

BG-FILCOTEN®

BG-FILCOTEN PRO V 200 Grates (8")

CHANNEL & TRENCH DRAINS

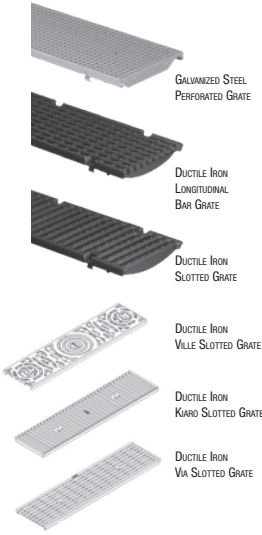

Part No.	Description	Material	Carton Qty.	Weight Ea. (lbs.)	Length Ea. (in.)	Product Class
17020104	BG-FILCOTEN 200 DI Bar Grate Class D 19.69 in	Ductile Iron	1	16.53	19.69	25FC
17020105	BG-FILCOTEN 200DI Bar Grate Class E 19.69 in	Ductile Iron	1	18.96	19.69	25FC
17020228	BG-FILCOTEN 200 G Perforated Grate Class C 39.27 in	Galvanized Steel	1	29.76	39.37	25FC
17020229	BG-FILCOTEN 200 G Perforated Grate Class C 19.69 in	Galvanized Steel	1	14.77	19.69	25FC
17020180	Ductile Iron Design Grate "Ville" NW 200, 500/222/25, Class E 10 KN (Tec, Pro)", Slot Width Maximum 8mm	Ductile Iron	1	23.81	19.69	25DS
17020183	Ductile Iron Design Grate "Kiaro" NW 200, 500/222/20, Class D 400 KN, (Tec, Pro), Slot/Mesh Width 200X5.7mm	Ductile Iron	1	20.72	19.69	25DS
17020184	Ductile Iron Design Grate "Via" NW 200, 500/222/20, Class D 400 KN, (Pro), Slot/Mesh Width 29X6mm	Ductile Iron	1	18.52	19.69	25DS

See load recommendation guide page 87

BG-FILCOTEN PRO V 300 Grates (12")



Part No.	Description	Material	Carton Qty.	Weight Ea. (lbs.)	Length Ea. (in.)	Product Class
17030103	BG-FILCOTEN 300 DI Bar Grate Class E 19.69 in	Ductile Iron	1	39.46	19.69	25FC
32110	Bolt for Ductile Grate (Order 4 Per 1/2 meter Grate)					
17030222	BG-FILCOTEN 300 G Mesh Grate Class C 39.37 in	Galvanized Steel	1	50.93	39.37	25FC
32112	Bolt for Galvanized Mesh Grate (Order 4 Per Grate)					
17030223	BG-FILCOTEN 300 G Mesh Grate Class C 19.69 In	Galvanized Steel	1	25.57	19.69	25FC
17030180	Ductile Iron Design Grate "Ville" NW 300, 500/347/25, Class E 600 KN (Pro) 4 Point Bolting-Device," Slot Width Maximum 8mm, Order Bolting Material Separately	Ductile Iron	1	44.09	19.69	25DS
17030183	Ductile Iron Design Grate "Kiaro" NW 300, 500/347/25, Class D 400 KN, (Pro) 4 Point Bolting-Device, Slot/Mesh Width 300X5.7mm, Order Bolting Material Separately	Ductile Iron	1	44.09	19.69	25DS
17030184	Ductile Iron Design Grate "Via" NW 300, 500/347/25, Class D 400 KN, (Pro) 4 Point Bolting-Device, Slot/Mesh Width 29X6mm, Order Bolting Material Separately	Ductile Iron	1	38.58	19.69	25DS

See load recommendation guide page 87

BG-FILCOTEN®

BG-FILCOTEN TEC V 100 Accessories (4")

BG-FILCOTEN Tec Sump Unit 100

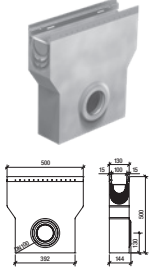

Part No.	Description	Material	Weight Ea. (lbs.)	Product Class
19011204	BG-FILCOTEN No Hub Bottom Outlet	Galvanized Steel	0.66	25FC
22515	BG-FILCOTEN 100 Silt Bucket for Sump	Plastic	0.44	25FC
32087	BG-FILCOTEN 100 Anti-Vandalism Locking Device	Stainless Steel	0.22	25FC
19011204	BG-FILCOTEN 100 Bottom Outlet	Galvanized Steel	0.66	25FC
19010400	BG-FILCOTEN 100 End Cap Blank w/Knockout Outlet			25FC
19010902	BG-FILCOTEN 100 Rebar Support	Galvanized Steel	2.7	25FC
13399	BG-FILCOTEN Maintenance Box Opening Tool	N/A	0.22	25FC
10410294	BG-FILCOTEN Tec V 100 Sump Kit	N/A	26.55	25FC

BG-FILCOTEN PRO V 200 Accessories (8")

BG-FILCOTEN Pro Sump Unit 200

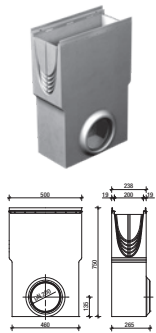

Part No.	Description	Material	Weight Ea. (lbs.)	Product Class
22512	BG-FILCOTEN 200 Silt Bucket for Sump	Plastic	1.54	25FC
32089	BG-FILCOTEN 200 Grate Vandal-Proof Device	Stainless Steel	0.22	25FC
70154	BG-FILCOTEN 8" Pipe Connector for Catch Basin	Plastic	2.43	25FC
19020215	BG-FILCOTEN 200 Closed End Cap	Galvanized Steel	0.88	25FC
19020216	BG-FILCOTEN 200 End Cap with Outlet	Galvanized Steel	1.10	25FC
19020295	BG-FILCOTEN Step Connector Plate	Galvanized Steel	0.44	25FC
19020902	BG-FILCOTEN No Hub Bottom Outlet	Galvanized Steel	2.20	25FC
19020902	BG-FILCOTEN Rebar Support	Galvanized Steel	1.8	25FC
19021208	BG-FILCOTEN No Hub Bottom Outlet	Galvanized Steel	2.2	25FC
10620292	BG-FILCOTEN Catch Basin includes 10620290 catch basin and 22512 Sediment Bucket	Galvanized Rail	180.0	25FC

BG-FILCOTEN PRO V 300 Accessories (12")

BG-FILCOTEN Pro 300 Sump Kit with Silt Bucket

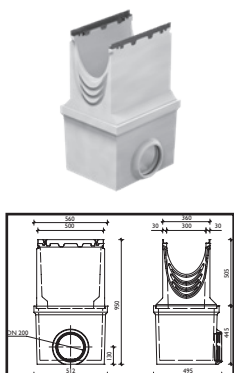

Part No.	Description	Material	Weight Ea. (lbs.)	Product Class
22213	BG-FILCOTEN 300 Silt Bucket for Sump	Galvanized Steel	7.05	25FC
32110	BG-FILCOTEN 300 Bolt and Nut for Locking	Galvanized Steel	0.22	25FC
19030213	BG-FILCOTEN 300 Closed End Cap	Galvanized Steel	3.75	25FC
19030214	BG-FILCOTEN 300 End Cap with Outlet	Galvanized Steel	3.53	25FC
19030290	BG-FILCOTEN 300 Catch Basin End Cap Connector	Galvanized Steel	0.66	25FC
19030295	BG-FILCOTEN 300 Step Connector Plate	Galvanized Steel	0.88	25FC
10630292	BG-FILCOTEN Catch Basin includes 10630290 Catch Basin Body and 22213 Sediment Bucket	Galvanized Rail	273.37	25FC
1903092	BG-FILCOTEN Rebar Support	Galvanized Steel	2.4	25FC

BG-FILCOTEN®

BG-FILCOTEN System Profiles

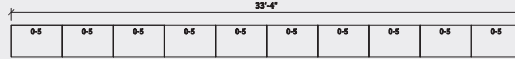

Neutral Run - neutral runs can be any length

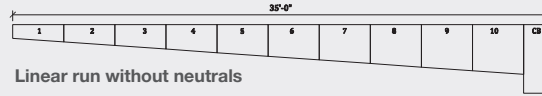

Linear run without neutrals

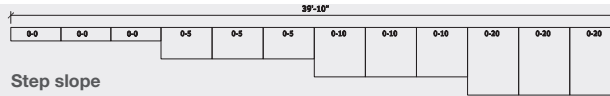

Step slope

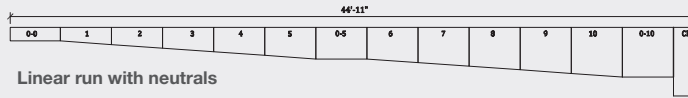

Linear run with neutrals

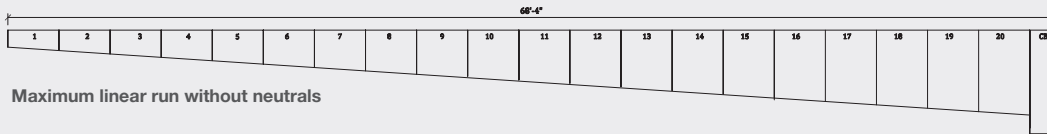

Maximum linear run without neutrals

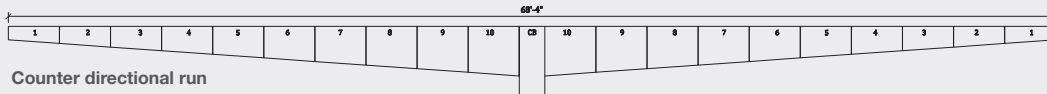

Counter directional run

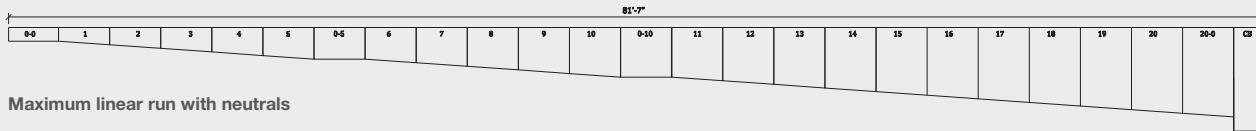

Maximum linear run with neutrals

Drawings are not to scale. See previous pages for actual product dimensions.

The maximum run length using only sloped channels with a catch basin in the middle is 135'. The maximum run length with all slopes with 1 each of the neutrals and a catch basin in the middle would be 162'.

BG-FILCOTEN®

LOAD RECOMMENDATION GUIDE – According to EN1433 Standards

Class A

- Max Design Load: 3,372 lbs.
- Pedestrians
- Bicyclists
- Planted Areas



Class B

- Max Design Load: 28,100 lbs.
- Pedestrians
- Parking Lots
- Delivery Vehicles



Class C

- Max Design Load: 56,200 lbs.
- Curbs
- Road Shoulders
- Parking Lots



Class D

- Max Design Load: 89,920 lbs.
- Roadways
- Pedestrian Zones
- Parking Lots



Class E

- Max Design Load: 134,800 lbs.
- Industry
- Military
- High Wheel Loads

Notes: Some installations may require a concrete collar to meet load rating. Load ratings are based on encasing product in concrete. Product must be installed using NDS instructions.

Cast iron grates will oxidize over time and rust, forming an iron-oxide patina. The iron-oxide layer begins red-orange in color and ages to a deep, rich brown. This patina is tightly adhered and protects the iron beneath it from further oxidation. Iron grates with a rust patina are structurally sound and will last for decades.

Visit [ndspro.com](https://www.ndspro.com) for complete installation specifications, guidelines & details.

CHANNEL & TRENCH DRAINS PRODUCTS INDEX

CHANNEL & TRENCH DRAINS

Part No.	Page	Part No.	Page	Part No.	Page	Part No.	Page	Part No.	Page
229	60, 64	665	73	8303	56	10410202	81	10630213	82
230	56, 59, 61	710	64	8381	56	10410203	81	10630214	82
234	61	712	64	8382	56	10410204	81	10630215	82
240	60	713	64	8383	56	10410205	81	10630216	82
241	60	714	64	8461	56	10410206	81	10630217	82
242	60	764	64	8462	56	10410207	81	10630218	82
243	60	800	66	8463	56	10410208	81	10630219	82
244	60	812	66	8471	56	10410209	81	10630220	82
245	61	813	66	8472	56	10410210	81	10630261	82
246	61	814	65	8473	56	10410211	81	10630262	82
247	61	815	65	8481	56	10410212	81	10630264	82
248	61	816	65	8501	56	10410213	81	10630290	82
249	61	817	65	8502	56	10410214	81	10630292	85
251	60	818	65	8503	56	10410215	81	17010105	83
252	60	819	65	8511	56	10410216	81	17010106	83
252CI	60	820	66	8512	56	10410217	81	17010110	83
252GY	60	821	66	8513	56	10410218	81	17010180	83
252S	60	822	66	8601	56	10410219	81	17010183	83
253	60	823	65	8651	56	10410220	81	17010184	83
253CI	60	824	65	8652	56	10410261	81	17010202	83
253GY	60	826	65	8653	56	10410262	81	17010203	83
253S	60	828	65	9206	57	10410264	81	17010204	83
254	60	829	60, 65, 67	9206GKIT	57	10410294	85	17010205	83
400	60	830	68	9206SKIT	57	10620200	82	17010206	83
400-10	60	831	68	9209	57	10620201	82	17010207	83
400-10MTL	60	832	68	9209GRAY	57	10620202	82	17010220	83
400-10WH	60	833	68	9209SAND	57	10620203	82	17010221	83
500	58	834	68	9209WHITE	57	10620204	82	17010228	83
500S	58	836	67	9241	57	10620205	82	17010229	83
529	58, 59	837	67	9242	57	10620206	82	17010401	83
532	59	838	67	9243	57	10620207	82	17010402	83
533	59	840	69	9247	57	10620208	82	17020104	84
540	58	841	69	9248	57	10620209	82	17020105	84
541	58	843	69	9250	57	10620210	82	17020180	84
542	58	844	69	9251	57	10620211	82	17020183	84
543	58	846	58	9252	57	10620212	82	17020184	84
544	58	847	69	9253	57	10620213	82	17020228	84
546	59	849	69	9261	57	10620214	82	17020229	84
546S	59	861	66	9262	57	10620215	82	17030103	84
547	59	862	66	9263	57	10620216	82	17030180	84
547S	59	864	65	9270	57	10620217	82	17030183	84
548	59	864DISPLAY	65	9301	57	10620218	82	17030184	84
548S	59	864GMTL	65	9302	57	10620219	82	17030222	84
550	59	864GMTLDISP	65	9303	57	10620220	82	17030223	84
551	58	885	69	9371	57	10620261	82	17111204	83
552B	58	888	67	9372	57	10620262	82	17111205	83
553PB	58	2301	61	9373	57	10620264	82	17111206	83
554	58	2350	61	9381	57	10620290	82	17111304	83
554CI	58	2351	61	9382	57	10620292	85	17111305	83
554GY	58	2361	61	9383	57	10630200	82	17111306	83
554S	58	2371	61	13399	74, 85	10630201	82	19010400	85
555	58	2381	61	22213	85	10630202	82	19010902	85
555CI	58	5300	59	22512	85	10630203	82	19011204	85
555GY	58	5303	59	22515	85	10630204	82	19020215	85
555S	58	5370	59	32087	85	10630205	82	19020216	85
629	75	5380	59	32089	85	10630206	82	19020295	85
660	73	5383	59	32110	84, 85	10630207	82	19020902	85
661	73	8001	56	32112	84	10630208	82	19021208	85
661LG	73	8002	56	70154	85	10630209	82	19030213	85
662	73	8003	56	1903092	85	10630210	82	19030214	85
663	73	8301	56	10410200	81	10630211	82	19030290	85
664	73	8302	56	10410201	81	10630212	82	19030295	85

You Click, You Order. No Waiting.

Getting connected is easy... set up your account online, or call customer service. 800-7261994. Se Habla Español.

ndspro.net

The 24 hour online dealer tool that helps you manage your NDS Business

Pricing Query

Instant Order Entry, No Wait

Check Discount Schedules

Check Order Status

Invoice Printing

Inventory Query

Manage Your Account

News Updates

Links to ndspro.com and Literature Direct



NEW! Shopping Cart
Easy to Use & Convenient

TERMS AND CONDITIONS OF SALE

Terms: Standard terms are NET 30 days. All invoices are to be paid in US Currency. Title and risk of loss pass to buyer upon shipment.

Freight Allowance: Freight prepaid on orders of \$2000.00 NET or more, with the exception of shipments to HI, Canada, AK, and PR Prepaid freight levels are based on shipments to one location only. It is the responsibility of the customer to determine if his purchase order meets the minimum freight allowance required. NDS reserves the right to select the carrier and point of shipment.

Canada, Hawaii, Puerto Rico & Alaska orders that include EZflow must be a minimum of \$4000 for prepaid freight Terms.

Canada, Puerto Rico & Alaska: Freight prepaid on orders of \$2500.00 (US\$) NET or more.

Hawaii Orders: Freight prepaid on orders of \$3500 NET or more.

Errors & Claims: All claims for shortage in shipment or damaged material must be noted on the “Bill of Lading” and a written request for credit submitted to NDS within 15 days of shipment. NDS responsibility ceases upon delivery to the carrier.

Returned Goods: Returned goods will be accepted only after written approval and shipping instructions are received from NDS. A return goods authorization number is required and must be on all cartons, documents, and correspondence. All returns are subject to a 25% restocking charge, freight cost of returned goods (plus “out freight if applicable”). A higher restocking charge may be assessed against any return requiring extraordinary handling costs.

Minimum Order: \$100.00 minimum order net billing.

Broken Box Charge: A 25% broken box charge will be added for other than full box quantities. 21DI Drip Components, 25DS Dura Slope Channel and 25FC Filcoten Channel are excluded from this policy.

Limited One Year Warranty: The liabilities of NDS are limited solely and exclusively to replacement as set forth in our standard “Statement of Warranty”, alone and do not include any liability for incidental, consequential or other damage of any kind whatsoever, whether any claim is based upon theories of contract, warranty, negligence or tort and without any limitations and do not include shipping charges, labor, installation or any other losses or expenses incurred in operation of any replacement specialty item or fitting. NDS drainage products are designed to be used for exterior surface drainage only.

All NDS products are guaranteed against defects resulting from faulty workmanship or materials. Claims for labor costs and other expenses required to replace defective products or repair of any damage resulting from the use thereof will not be allowed by NDS. Our liability is limited to replacement of products acknowledged by NDS to be defective.

Exclusive Warranties and Remedies: The foregoing remedies are exclusive and are given and accepted in lieu of (i) any and all other warranties, expressed or implied, including without limitation the implied warranties of merchantability and fitness for particular purpose; and (ii) any obligation, liability, right, claim or remedy in contract or tort, whether or not arising from NDS, Inc.’s negligence, actual or imputed. The remedies of customer shall be limited to those provided herein to the exclusion of any and all other remedies including, without limitation, incidental or consequential damages. No agreement varying or extending the foregoing warranties or these limitations will be binding on NDS, Inc., unless such is signed in writing by an authorized officer of NDS, Inc.

The liability of NDS, Inc., hereunder shall be limited to restoring to good working order, provided that NDS, Inc., is not required to restore the product to good working order when such failure is due to causes beyond NDS, Inc.’s control, including but not limited to, acts of God, acts of civil or military authority, priorities, strikes, floods, epidemics, war, riots, and other causes that are beyond the manufacturers control.

These provisions are complete and exclusive statements of all terms and conditions between NDS, Inc., and the consumer. These provisions may not be varied, supplemented, qualified or interpreted by any prior course of dealings, written or oral or by trade usage. No NDS, Inc. agent, officer or employee has authority to make any representation, promise or warranty concerning these provisions.

FOR TECHNICAL INFORMATION, CONTACT: Technical Services, (888) 825-4716, TechService@ndspro.com

Visit ndspro.com for more information.

Our products are engineered and produced for performance, durability, ease of installation and the efficient use of resources.



Your knowledgeable and trusted partner for the best in water management solutions



Residential Stormwater Management | Commercial Stormwater Management | Professional Irrigation | Flow Management

Visit ndspro.com for:



Videos



Tools/
Calculators



Downloads



Case
Studies



Design
Worx



Request
a Quote

ndspro.com

NDS Customer Service
851 N. Harvard Ave., Lindsay, CA 93247
Phone: 800.726.1994 · 559.562.9888
Fax: 800.726.1998 · 559.562.4488
Se Habla Español

Download our
**Mobile App - Search
for NDS Drainage**



A Proud Member of



California Prop 65 Warning | To meet the requirements of California Proposition 65, it is our responsibility to inform you of the following:
Warning Some products sold contain chemicals known to the state of California to cause cancer, birth defects, or other reproductive harm.
For more information, please go to www.P65Warnings.ca.gov